



ALUMINUM SOFFIT, FASCIA & RAINWARE INSTALLATION GUIDE



GENTEK®

GENTEK BUILDING PRODUCTS

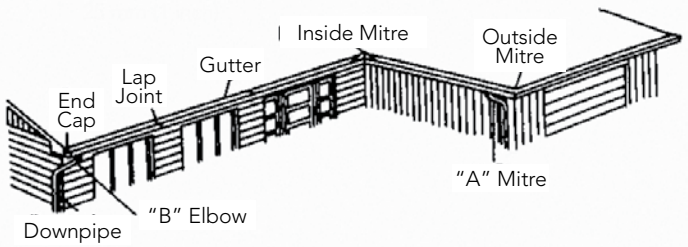

General Information

Gentek Building Products supplies K style gutter in the standard 5" size. Contact your local branch for standard lengths and sizes in your area.

* This installation guide applies to the standard 5" gutter.

During installation take care not to damage the baked enamel finish. When installation is complete wash the finish with a non-abrasive liquid cleaner. Touch up the heads of all pop rivets to match the gutter, elbow and downpipe colour. Working on one wall at a time, assemble gutter and accessories on the ground, starting with a corner or the end of a run. Allow a minimum of 65 mm (2 1/2") of gutter length for each lap joint.

Note: All measurements are written in the SI metric system, nominal imperial equivalents are provided in brackets.

Lap Joints

Start the lap by cutting 65 mm (2 1/2") off the top of the inside gutter front lip. Apply two beads of gutter sealant, 2 mm (1/16") thick over the inside of the outside gutter, the first bead a minimum 12 mm (1/2") from the gutter end and the second bead 25 mm (1") further in. (See Fig.1).

Fit the two gutter ends together (see Fig. 2) fastening them with seven pop rivets located between the two beads of sealant - two in the front, three in the bottom, two in the rear - making sure the completed lap is snug and free from gaps. Use a No. 30 drill for pop rivets holes. Apply sealant to the full length of seam and to pop rivets. Fit laps so that water runs over, not into, the lap joint.

In locations where the temperature range is large, pop rivets may fracture due to expansion and contraction of gutter with a total "straight line" length over 6 m (20').

Alternatively, a 65 mm (2 1/2") overlap - with generous beads of high grade silicone sealant which retains its elasticity - may prove more satisfactory. Try to ensure there is a spike and ferrule or gutter bracket close to the joint to provide good support.

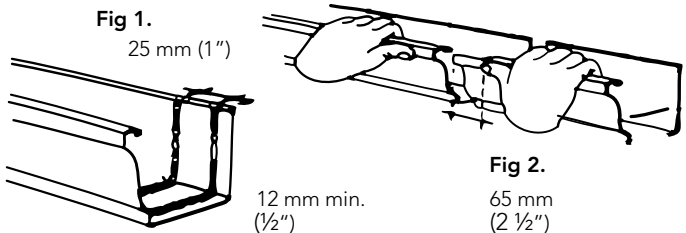

End Caps

Apply a bead of sealant inside the gutter over the full length of the joint between the end cap and gutter. Seat the cap over the gutter end and tap lightly with a hammer. Fasten the cap to the gutter in at least three places – one each at the front, the bottom, and the rear – using pop rivets or crimping tool. (See Fig. 3).

Hanging Gutter

Note: Check outlet locations before commencing hanging.

Beginning at the end furthest from the downpipe outlet, slope the gutter at least 6 mm per 3 metres (1/4" per 10 ft) of run toward the nearest outlet. (See fig. 4). A long run may require an outlet at either end, in which case the slope is measured from the mid-point.

Hang the gutter with either aluminum spikes and ferrules (see Fig. 5) or Gentek gutter brackets. (See Fig. 6).

When hanging with spikes and ferrules, use the ferrule as a back-up, driving the spike through the face of the gutter front lip, ferrule and gutter back into the fascia board, roof rafter or lookout. To avoid denting or distorting the gutter, drive the spikes to only a snug fit. If the fascia board is nominal 25 mm (1") thick, or less, drive the spikes into the ends of the rafters or roof trusses.

When hanging with the Gentek gutter bracket, secure the bracket to the fascia board with minimum 38 mm (1 1/2") aluminum or hot dip galvanized spiral shank nails or No. 12 x 25 mm (1") hot dip galvanized wood screws (two nails or screws per bracket). Either spikes and ferrules or gutter brackets should be spaced not more than 800 mm (32") apart.

Fig 3.

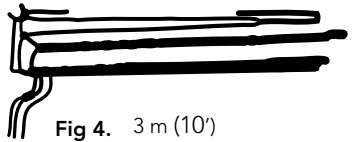
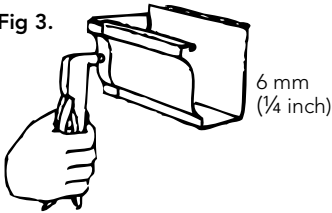

Crimping Tool

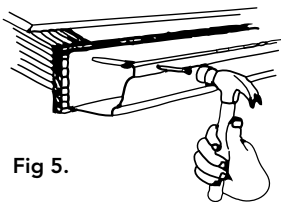

Fig 5.

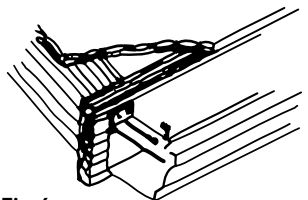

Fig 6.

If the fascia board is nominal 25 mm (1") thick, or less, drive the spikes into the ends of the rafters or roof trusses.

When hanging with the Gentek gutter bracket, secure the bracket to the fascia board with minimum 38 mm (1 ½") aluminum or hot dip galvanized spiral shank nails or No. 12 x 25 mm (1") hot dip galvanized wood screws (two nails or screws per bracket). Either spikes and ferrules or gutter brackets should be spaced not more than 800 mm (32") apart.

Gutter Corners

Using an inside or outside mitre, as required, apply sealant as described under "Lap Joints". Fit the first length of gutter into the mitre, seal and fasten securely as described under "Lap Joints". Fit the second length of gutter into the mitre and fasten as before. After assembly, be sure to apply sealant to the full length of all joints between gutter and mitre, all mitre seams and pop rivets. (See Fig. 7).

Downpipes

One downpipe is usually enough for the run-off from 45m² to 55m² (475 to 600 sq. ft) of roof area. At the locations where downpipes are needed, cut holes in the bottom of the gutter the same sizes and shapes as the outlets. For aluminum outlets, spread sealant on the underside of the flange, drop the outlet into the hole in the gutter and fasten outlet and gutter securely together with four pop rivets. For round plastic outlets, use a hole saw in an electric drill to cut the required accurately sized hole in the gutter. Push the outlet down until it snaps into place in the gutter.

Fit the elbow or downpipe over the bottom end of the outlet and fasten it securely to the aluminum outlet with two pop rivets, or to the plastic outlet with two aluminum or plated steel self tapping screws one each on opposite sides of the elbow or downpipe.

For best appearance, the side of the downpipe containing the seam should be against the wall. Use two "A" elbows to bring the downpipe against the wall and two "B" elbows to move it to the right or left. Connect elbow and downpipe by inserting the male end on one length into the female end of another, pop-riveting all connections and making the installation so that the female ends of elbows and downpipes face upwards. (See Fig. 8).

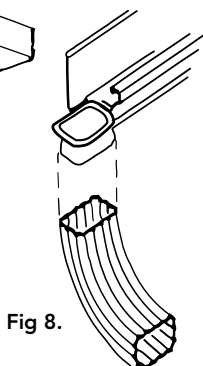
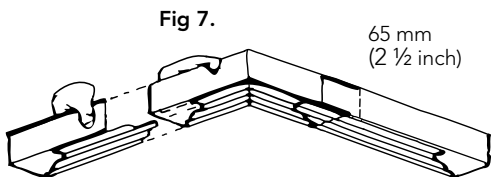

Using same nail spacing and sizes, install soffit "J" trim to cover edge of first soffit panel at end or at square or mitred corner of soffit installation.

At corners, cut mitre only when soffit lengths are equal on both sides of corner and install back-to-back "J" channels at mitred soffit edges.

Wherever possible, downpipe should run down the side rather than the front of the building. To run the long side of the downpipe against the wall from a gutter on the building front it is necessary to use a style "B" elbow. In such cases be sure aluminum outlets are positioned properly in the gutter. Fasten the downpipe to the building wall with aluminum straps. Use a strap adjacent to the upper elbow at the wall and at least every 3 m (10') of straight run of downpipe. Unless the downpipe leads into a drain tile, use an "A" elbow at the bottom of the run to direct water away from the building foundation. (See Fig. 9).

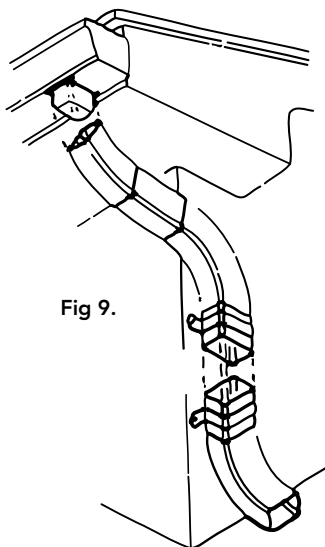

Dams (optional)

In heavy rainstorms, overflow of gutters sometimes occurs at corners where two roof surfaces meet to form a valley. Overflow may be minimized or eliminated by installing a dam in the gutter. Cut a triangular piece of aluminum sheet, bend it and rivet it to the underside of the gutter front lip. (See Fig. 10).

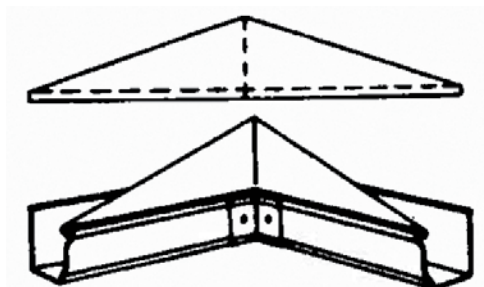



Plastic Outlet

Downpipe Strap



Ferrules



75° "A" Elbow

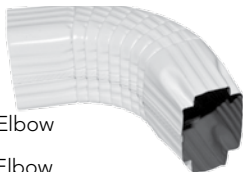

75° "B" Elbow



End Cap



67 x 67 mm
(2 5/8" x 2 5/8")
Square Elbow

Gutter Bracket



5" K-Sty Gutter

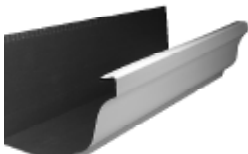

Inside Mitre



67 x 67 mm
(2 5/8" x 2 5/8")
Aluminum Outlet



67 x
(2 5/8")
Dov



75 x 50 mm
(3" x 2")
Aluminum Outlet



75 x 50 mm
(3" x 2") and 75 x 75 mm
(4" x 3")
Downpipe Aluminum Outlet



Outside Mitre



Aluminum Strainer



Aluminum Pop rivets



Touch-up Paint



Painted Coil Stock (for Gutter Machines)



150 & 175 mm
(6" & 7")
Aluminum Spike



Spray Bomb



Crimping Tool



Gutter Sealant

SOFFIT & FASCIA INSTALLATION

General:

All Gentek Siding and Soffits comply with CAN/CGSB-93.2M91, Canadian Norms for Prefinished Aluminum Siding, Soffits and Fascia, for Residential use.

Gentek Soffit is available in a variety of profiles. Vented panels are designed to allow air circulation into the attic areas to aid in the reduction of excessive heat build-up and water vapour condensation.

Following are the free flowing ventilation areas for Gentek soffit products.

PROFILE	PER LINEAR FOOT	PER PANEL
16" – 2 panel	4.02 sq. in. 26.0 cm ²	48.7 sq. in. 314 cm ²
18" – 3 panel	5.46 sq. in. 32.2 cm ²	54.6 sq. in. 352.26 cm ²
16" – 4 panel	4.12 sq. in. 26.0 cm ²	51.25 sq. in. 330.64 cm ²

VENTILATION: fully vented

To meet the National Building Code requirements, attic spaces require a free flow vent area of 92,900 mm²(1 ft²) for 27.9 m² (300 ft²) of insulated ceiling area.

Gentek roll-formed fascia is supplied in 100 mm (4"), 152 mm (6") and 203 mm (8") widths, in 3 m (10') lengths. Soffit and fascia can be installed in new constructions as well as in re-siding projects.

Soffit Installation

In new residential construction the building contractor must prepare for Gentek soffit application by installing a 50 mm x 50 mm (2" x 2") nailing strip (see Fig. 1), on which will be installed a soffit "J" trim. This nailing strip is seldom necessary in renovation soffit applications because it is usually possible to nail a soffit "J" trim directly to existing wood surfaces.

The bottom edge of this nailing strip and the fascia board must be at the same level. Measure from the bottom of the installed soffit "J" to the outer face of the fascia board and cut soffit panels 6 mm (1/4") shorter than this measurement, using a circular saw with suitable metal-cutting blade. Note: Because the distance from the building wall to the fascia board may vary by more than 6 mm (1/4") throughout the wall length, it is wise to check the measurement at several points before cutting fascia panels.

To begin soffit installation, nail soffit "J" trim to nailing strip or to other wood surface at the corner where wall and soffit meet. Note: Nail on 400 mm (16") centres with 25 mm or 38 mm (1" or 1 1/2") aluminum nails.

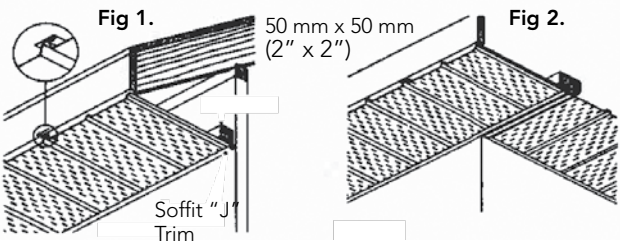

When square corner is used (see Fig. 2) always extend "J" channels the full length of front and rear of building including the side soffit overhangs, and install back-to-back "J" channels at junction between front or rear and side soffit panels.

Slip the end and the nailing tongue edge of the first soffit panel into the "J" at the building wall and/or corner of the roof overhang and nail with 25 mm (1") or 38 mm (1 1/2") prefinished aluminum nails, one nail in each of the soffit main grooves at the fascia board end and one nail in the soffit nailing edge at the wall end.

Insert nailing tongue of the next soffit panel into locking groove of first soffit panel and nail as before, continuing the way along the overhang.

Fascia Installation

Fascia is usually installed with roof shingles already in place. In new construction, trim roof sheathing flush with face of wood fascia board. The roofing contractor should nail the first course of shingles approximately 75 mm (3") above the butt edge. Bend fascia top edge 25 mm (1"), insert under shingles and, while shingles edges are lifted, nail fascia top edge through roof sheathing and into wood fascia using aluminum siding nails on 600 mm (24") or 900 mm (36") centres. Using aluminum nails colour-matched to fascia, nail fascia bottom edge up through soffit on approximately 760 mm (30") centres (see Fig. 3).

Alternative installation:

As an alternative installation method with roof shingles already in place (see Fig. 4), bend fascia top edge 12 mm (1/2") and face nail with 25 mm (1") prefinished aluminum nails colour-matched to fascia. Use two rows of nails, one row approximately 25 mm (1") below the top edge of the fascia, the other approximately 25 mm (1") above the bottom edge. Nail on 760 mm (30") centres.

As an alternative to bending the fascia top edge, install large sill trim, using 25 mm (1") or 38 mm (1 1/2") prefinished aluminum nails on 400 mm (16") centres (see Fig. 5). Cut fascia to required width and, after crimping the top section with Crimping Tool (cat. FA-1-C) on approximately 400 mm (16") centres, slip the fascia cut edge in the large sill trim so that the crimps secure it in place. Using 25 mm (1") prefinished aluminum nails colour-matched to fascia, face nail the fascia approximately 25 mm (1") above bottom edge on 760 mm (30") centres.

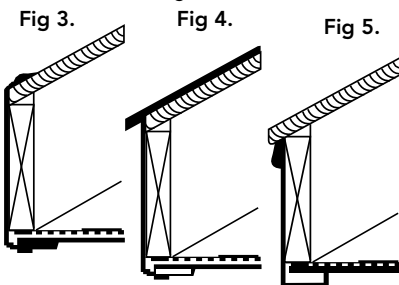

1) Don't drive face nails so tight that they distort the fascia surface.

2) Overlap adjacent fascia panels 12 mm (1/2") by notching one of the panels to remove the vertical return. Always lap so that exposed edges face to the rear and sides away from building entrance.

- NOTES -

- NOTES -



GENTEK®

GENTEK BUILDING PRODUCTS

Gentek Building Products Installation Guides are for information only. If you are unsure of any procedure, consult Gentek Building Products or a qualified tradesman for advice. They can provide the information you need – and save you time and trouble.

Product Improvement Policy: Gentek Building Products is constantly improving product designs and manufacturing processes. We therefore must reserve the right to change specifications without notice. Please consult Gentek Building Products for current details. © 2013, Gentek Building Products.

Visit our site at www.gentek.ca