

MÉTALUNIC
DESIGN

La beauté naturelle
du vrai bois sans l'entretien

*All the beauty of wood
without the maintenance*

ÉLÉGANT - DISTINGUISHED
- ÉLÉGANT - DISTINGUISHED

DURABLE - PEACE OF MIND
- DURABLE - PEACE OF MIND

RÉSISTANT UV - UV RESISTANT
- RÉSISTANT UV - UV RESISTANT



METALUNICDESIGN.COM

INSTALLATION GUIDE
MODERNO



WARNING !

Like any other metal siding, this product may have sharp edges. It is therefore important to handle the product with caution. We recommend you wear the proper protective equipment: boots, helmet, goggles and safety gloves.



GUARANTEE

For the guarantee to be honoured, installation must be carried out following your region's established building code standards and as recommended by the manufacturer. Should a problem occur when installing the panels, it is important to notify Métalunic Design before the installation of 2 complete boxes (a total of 126 sq. ft.) to ensure that the guarantee applies. *For more information, refer to the guarantee.*

ORDER BATCH

It is important to note that the Granite® Deep Mat Series and the Metallic Silver colours may vary slightly from one batch of orders to another. This does not change the paint quality of the siding in any way. At moment of purchase, make sure to order enough material to ensure completion of your project in an effort to minimize the risk of colour variations.

RECEPTION AND INSPECTION

Upon receiving Moderno siding, it is important to inspect the product immediately. Should there be a mistake with the order, or damaged panels, your supplier must be notified as quickly as possible.

HANDLING

Handle the box with care and always lift it on its side, never flat. This way you will avoid warping the product.



STORAGE

To maintain the aesthetic and physical properties of Moderno metal siding, it is important to follow certain storage guidelines.

If the siding cannot be installed upon reception, or during winter, store the product indoors in a dry, temperate and ventilated area until installation. Outdoor storage is at the client's own risk.

Before removing the protective film from the product, make sure the panel's temperature is above the freezing point (above 0 degrees Celsius). Once the siding temperature is above 0 °C, the protective film can safely be removed.

If the product must absolutely be stored outdoors (not recommended for guarantee purposes), make sure to store the panels and any other mouldings and/or accessories sheltered from direct exposure to the sun, rain and extreme outdoor temperatures. These factors may cause the protective film to adhere to Moderno panels. The protective film may be more difficult to remove and leave a residue of glue on the panel. Using a tarp to protect the product is also recommended. Before installation, the product must be stored in a dry, temperate and ventilated area for 24 to 48 hours.

THE NUANCED WOOD SERIES

The Nuanced Wood Series is characterized by a nuanced paint system that reproduces the appearance of real wood. Each box contains 12 panels with different grains and shades which are numbered from 1 to 6 on the attaching strip. There is a minimum of 5 shade numbers per box.



#1 and #2 Pale shades.
#3 and #4 Medium shades.
#5 and #6 Darker shades.

THE NUANCED WOOD SERIES - continued

During installation, make sure to position the boards randomly and shuffle them along the length as well as the height. It is important not to repeat the same pattern when installing, and to check on the work being done by backing away from the building every 3 or 4 rows. This way, you will be able to see inconsistencies, or the unwanted effect of the same colour repeating, and adjust your method accordingly.

For best results and a natural look, cut, mix and match shades and lengths in narrow spaces also, to be joined on furring strips. Avoid a too-even layer-cake look.

The supplied images are examples only.

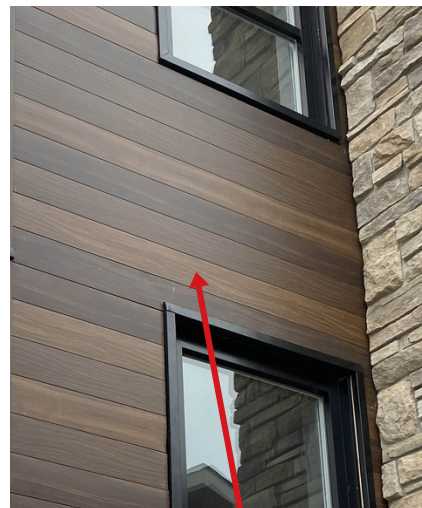

Avoid a layer-cake look by mixing shades even in the narrower spaces



TOOLS AND ACCESSORIES

To install Moderno siding, you will need the following tools and accessories:



Spirit or laser level



Tape measure



Drill/driver



Caulking gun and caulking



Sheet metal shears



Hand seamer



Edge folding tool



Moderno hand guillotine



Touch-up paint



Wood screws
#8 x 1-1/8"



Metal screws
#8 x 1/2"

For more information on the tools and accessories authorised by Métalunic Design for the installation of Moderno siding, please contact your supplier.

MOULDINGS

To produce a quality finish, Métalunic Design offers a complete range of mouldings that match your exterior siding.



Outside corner
CEDIS



Galvanized starter strip
DDISGV



J-moulding
JDIS



Inside corner
CIDIS



Conversion moulding
CDIS



Drip-cap moulding
EDIS



Partition moulding
PDIS



Steel rolls*

*Rolls of painted steel are available for the fabrication of particular parts by a supplier that specialises in sheet metal.

PREPARING THE SURFACE TO BE COVERED

First and foremost, make sure the surfaces you will be covering with Moderno exterior siding meet all industry standards in your region.

Métalunic Design strongly recommends relying on the building code of your province.

Level surface

Before beginning the installation, checking the structural integrity of the wall and making sure the surface is level, straight, solid and able to receive the siding is important.

This step is essential to minimizing the risk of defects and warping of the panel's profile.

Wood or metal furring strips

The installation of wood or metal furring strips is strongly recommended to insure proper ventilation between the wall and siding, and to avoid the risk of condensation.

Furring strips must be properly aligned and perpendicular to the siding's direction.

The siding can be installed horizontally or vertically. In either case, the furring strips must conform to the requirements of Moderno panels.

Horizontal

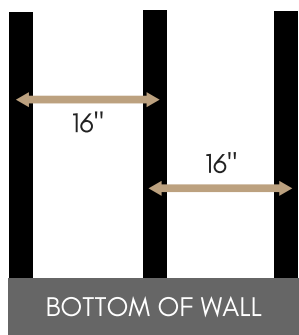

Specifications :

- 1"x 3" Wooden furring strips
- Furring strips 16" apart center to center
- Panels join on the furring strips

Vertical

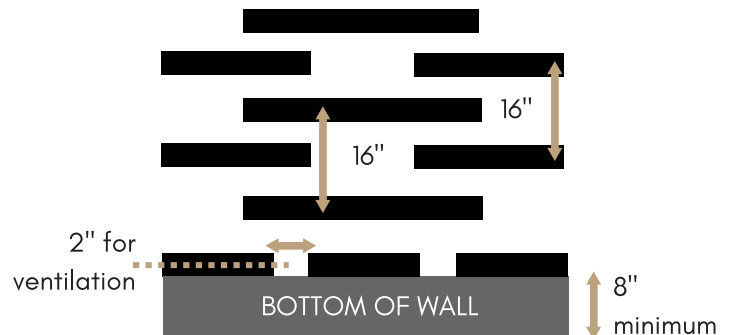

Specifications :

- 1"x 3" Wooden furring strips
- Furring strips 16" apart center to center
- No vertical joints
- 2" ventilation spaces
- 8" minimum from the ground

INSTALLATION

Once the wall surface is ready and able to receive Moderno siding, you can begin installing by following our installation guide. Installation of Moderno siding can be either horizontal or vertical. (Specifications for vertical installation on page 13.)

Starting strip

Using a spirit or laser level and a chalk line, trace a line in the direction of panel installation as a starting guide.

Attach and secure the starter strip using one Moderno screw while making sure the strip is straight and square to the guide line. When it is level, screw it into place. Important note, the Moderno starting strip needs to be installed in the opposite direction than the Distinction starting strip.

Moderno starting strip



Distinction starting strip



Using a level, make sure the installation area is level both horizontally and vertically (see the 2 images below). It is important to make sure the starting strip is level as it will guide your work during the entire installation.

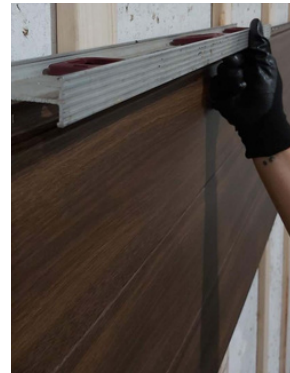

Moderno screws

Fastening must be done using the screws recommended and supplied by Métalunic Design, according to the type of surface being screwed to.



Wood screw



Metal screw

To not hinder the metal's expansion and contraction, drive Moderno screws every 16" and center them in the panel's holes, using moderate pressure, at a 90 degree angle. Screws must not exert pressure upward or downward to avoid warping the panel and/or opening the joint between panels. Refer to images on the next page.

Moderno screws – continued



Moderate pressure



Exaggerated pressure

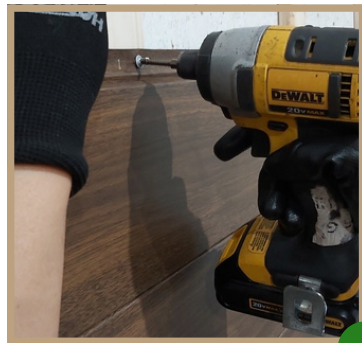

90 degree driving

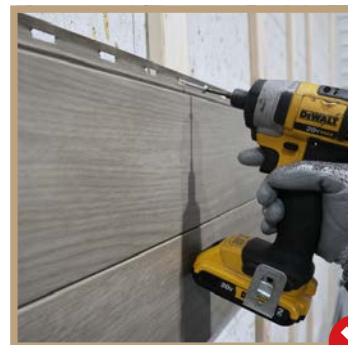

Driving at an angle

In the case of a furring strip that does not align, we suggest leaving a space between the wall and the furring strip by using a shim, and, if needed, leaving a space between the furring strip and the siding. Avoid putting too much pressure on the panel when screwing it in place, as this could cause warping. Refer to the images below.



Cutting

To cut panels, use the Moderno guillotine cutter, specially designed for the Moderno panel's cross-section. It gives precise cuts without slivers or rust. It does not burn the paint, and, thanks to its anti-crushing guard, will not warp the panel's cross-section. You can thus make clean cuts while reducing the stress on the product.

The Moderno guillotine and replacement blades are available for purchase*.

**Check with your supplier*



Make sure to position the anti-crushing guard properly to avoid putting pressure on the panel's profile.



*the use of a circular saw or any other cutting device other than the Moderno guillotine is not recommended by Métalunic Design and automatically voids the product guarantee.

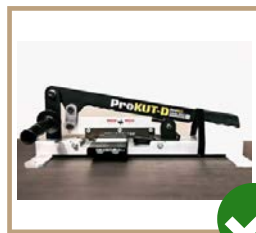

**Moderno
guillotine**



**Other cutting
tool(s)**

Touch-up paint

When making either visible or non-visible cuts to Moderno siding, applying Moderno touch-up paint to the edges is important. Failing to do so might void the guarantee.

If needed, the touch-up paint can also be applied to hide small scratches. It is important not to spread or daub the paint around on the surface, but to stipple it on lightly with a brush.

The protective film

Métalunic Design suggests you leave the protective film in place until installation. To avoid any damage to the coating, install a few rows high, remove their protective film and perform a visual inspection to verify product compliance.

As specified in the **STORAGE** section of this manual, the protective film should only be removed if the siding temperature is above 0°C.

Joints

An important note: only factory cuts can be used to join two panels. Cuts done on-site are only to be used behind mouldings..

For the horizontal installation of Moderno siding, the joint between 2 panels must be screwed directly to the wooden or metal furring strips.

For a nice joint finish without gaps, always add a second screw to the panel that was just installed.

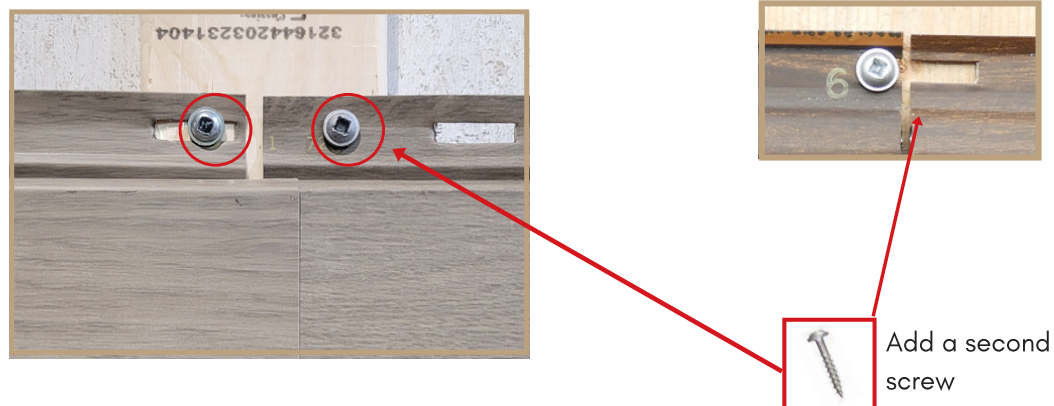

For the vertical installation of Moderno siding, overlapping the panels is not recommended because of the shrinkage effect of a multi-storey building and to avoid the risk of water seeping into the overlapping joint.

Expansion

When joining two panels, leave a 1/8" expansion gap to provide for the product's expansion according to the temperature. Also provide a 1/8" gap between the end of a panel and the mouldings.

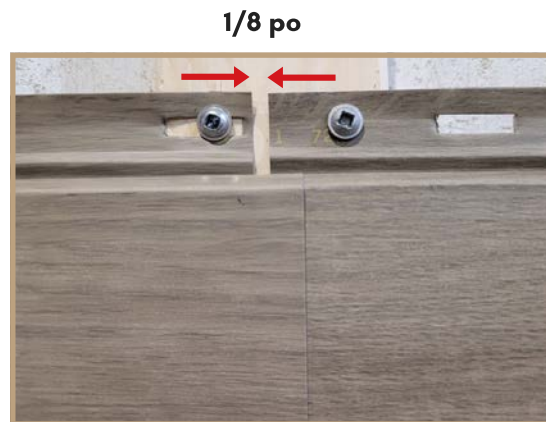

For buildings taller than one storey, plan for an expansion gap by installing a conversion moulding (CDIS) and a starter strip (DDISGV) every 10 feet up or at every new storey.

Moderno mouldings

Install corners, J-mouldings and Drip-cap mouldings at the required places by using the same screws as with Moderno panels.

Panel alignment at the corners

For a more aesthetic look, Moderno panels should align on both sides of a corner.

Use a carpenter's square or a level to make sure panels are at the same level. Check periodically after installing 4 or 5 rows on either side of a corner to make sure the panels are always aligned.



Door and window contours

Measure and adjust a Moderno panel as needed before installing.

To contour a window, first install a J-moulding below the window, then on either side of the window. Make sure the bottom J-moulding passes under the J-mouldings on either side. Continue installing the panels on either side while making sure to mix the various numbered shades.

Before installing a first panel above the window, first install a Drip-cap moulding, according to your region's building code, and attach it over the J-mouldings installed earlier.

For a door, install the moulding the same way as with a window, except for the J-moulding at the bottom of the door.

If installing a full-height panel above a door or window is impossible, trim the panel leaving an extra $\frac{1}{2}$ " to fold back behind the panel at 45 degrees to reinforce it.



VERTICAL INSTALLATION

Vertical installation of Moderno siding uses the same principles as horizontal installation. Certain important points, however, must be restated. Overlapping 2 panels vertically is not recommended as it might result in water seepage. This would void the guarantee.

Reminder - wooden or metal furring

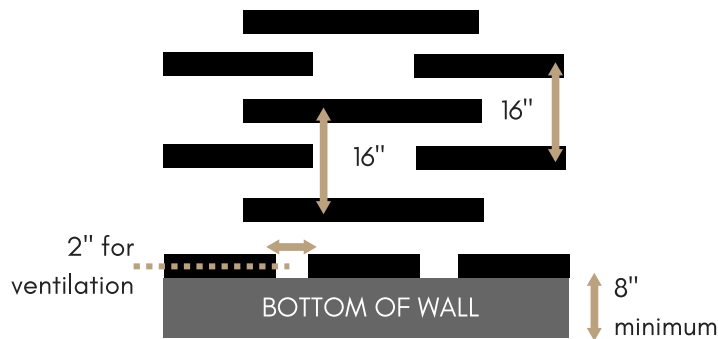

Specifications :

- 1"x 3" Wooden furring strips
- Furring strips 16" apart center to center
- No vertical joints
- 2" ventilation spaces
- 8" minimum from the ground

Starter strip

Instead of beginning with a Starter strip (DDISGV) at the bottom of the wall, begin with a Drip-cap moulding (EDIS) and leave a 1/8" gap at the bottom for the panel's expansion.



Expansion

As with horizontal installation, it is essential to plan for an expansion gap between different storeys or between each 12-foot panel. This should be done with a Conversion moulding (CDIS)

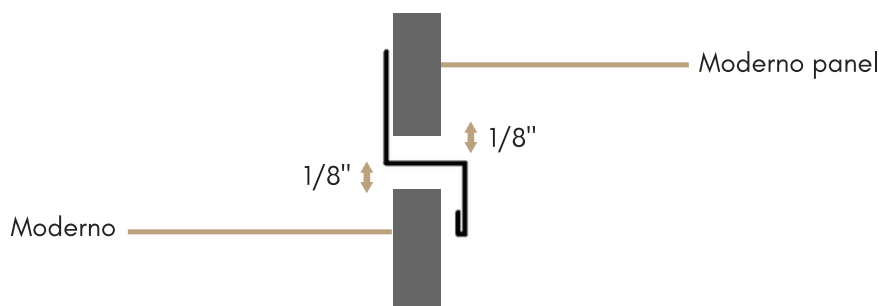



For more information on Moderno siding, please visit our website

www.metalunicdesign.com

or contact us directly at

(450) 267-2330