



THINK BEYOND WOOD®

LONG LASTING LOOKS THAT MAKE
A HOME LOOK EVEN BETTER.





We're leaving wood trim in the sawdust.

Homeowners want the look of real wood with none of the upkeep. Contractors want a product that's easy to work with and that they can trust. Kleer® is here to make them both happy, giving builders and homeowners the best of both worlds—a rich, unique appearance with low-maintenance durability.

Workability

Kleer doesn't just look like wood, it works like it. It goes up quickly and can be used in a number of applications including fascia, soffits, porch ceilings, wainscoting and more. You can even heat bend the boards to create truly unique designs.

100% Usable

Kleer is engineered to perfection. That means there's no knots or other unusable pieces like you can have with wood. So when you buy a board, you can use the entire board.

Clean Application

When Kleer goes up clean it stays brilliant for years to come. Our KleerPak® small quantity bundling and innovative TruEDGE® design helps to keep your boards clean on the job site so they can be installed for a perfect look.

If you run out of ways to use Kleer, you're not thinking hard enough.

If you can do it with wood, you can do it with Kleer Trimboard®. Get architecturally correct corners, fascia, soffits, rakes, casings, cornices and all kinds of other applications, each with the distinctive look and beauty of wood without the upkeep or rot. And just like wood, you can nail it, staple it, glue it and bend it and, if you want to, even paint it to create any piece of architectural millwork. Infused with UV inhibitors that provide long lasting protection, they are perfect for creating authentic accents with a look that will last for years to come.

TruEDGE®

Building homes can be a dirty job. So we created our innovative TruEDGE technology to give distributors, dealers and contractors a trimboard that can stand up to dust and dirt. TruEDGE is engineered to provide cleaner, smoother edges, and can be wiped clean easily, unlike wood and other PVC trimboards.



Results from a dirt intrusion test show how much easier Kleer is cleaned compared to competitors.

KleerPak®

The path from the manufacturing plant to installation can be hard on building materials. That's why we've designed and offered our signature KleerPak. This means that not only are the large packs of materials wrapped but they each contain multiple MiniPaks™ within it. Once the larger bundle is open these smaller packs keep boards clean until they are sold or used. Which helps both dealers and builders alike. In addition, this packaging allows dealers to sell smaller quantities without leaving the remaining stock exposed in the lumberyard or warehouse. Builders can use the boards they need on a job.

Kleer Trimboard®

ACTUAL THICKNESS	LENGTH	NOMINAL WIDTH (ACTUAL WIDTH)							
5/8"	18'	3 (2-1/2")	4 (3-1/2")	5 (4-1/2")	6 (5-1/2")	8 (7-1/4")	10 (9-1/4")	12 (11-1/4")	16 (15-1/4")
3/4"	18'								
15/16"	18', 20'								
*1-1/4"	18'								

Please check with your local dealer for product availability in your market. Custom widths and lengths available.

*1-1/4" Trimboards do not include TruEDGE technology.

Kleer Trimboard® with Nailing Flange Cutouts

Designed with a 1/4" cutout so they install flat over window nailing flanges for a more attractive finished product.

ACTUAL THICKNESS	LENGTH	NOMINAL WIDTH (ACTUAL WIDTH)	
15/16"	18', 20'	3 (2-1/2")	5 (4-1/2")

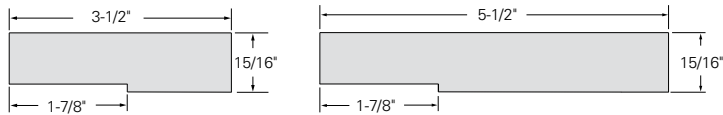

KLEERStart®

A 3/4" thick frieze board, the KLEERStart system allows siding to easily fit behind the trimboard, creating a seamless look.

ACTUAL THICKNESS	LENGTH	NOMINAL WIDTH (ACTUAL WIDTH)	
3/4"	18'	6 (5-1/2")	8 (7-1/2")

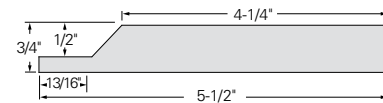

Kleer saves builders time and money by eliminating the lamination steps, previously necessary for thicker PVC designs.



Kleer Sheets®

With a wide range of thicknesses and sizes, Kleer Sheets offer the versatility for a variety of millwork applications, as well as for framing out multiple windows and other custom uses.

THICKNESS	WIDTH	LENGTHS
1/4"	4'	8', 10', 12'
3/8"	4'	8', 10', 12', 18'
1/2"	4'	8', 10', 12', 18'
5/8"	4'	8', 10', 12', 18'
3/4"	4'	8', 10', 12', 18', 20'
15/16"	4'	8', 10', 12', 18', 20'

Custom widths and lengths available. Please check with your local dealer for product availability in your market.

Like all our products, Kleer Sheets and Custom Sheets won't warp, crack, split, rot, peel or flake, allowing them to have direct contact with the ground or other potentially wet surfaces.

Kleer Custom Sheets

Kleer 1-1/4" Sheets are perfect for pergola beams, corbels, mouldings, and any custom PVC millwork.

THICKNESS	WIDTH*	LENGTHS
1-1/4"	4'	8', 10', 12', 18' 20'

**Nominal 48", Actual 47" ± 3/4"*

Custom widths and lengths available. Please check with your local dealer for product availability in your market.



Kleer Konceal®

The Konceal System is an innovative system of products from Kleer designed to save builders time and frustration without sacrificing a clean, finished look. These boards and corners have a built-in 3/4" reveal that covers rough cuts at corners as well as around windows and doors where precision cuts can be challenging. Kleer Konceal is available in smooth or natural wood grain textures so you can pair it with vinyl, fiber cement or wood siding.

SIZE	DESCRIPTION	LENGTH
5/4 x 4	Konceal Trimboard 15/16" x 3-1/2"	18'
5/4 x 4	With Nailing Flange Cutout 15/16" x 3-1/2"	18'
5/4 x 6	Konceal Trimboard 15/16" x 5-1/2"	18'
5/4 x 6	With Nailing Flange Cutout 15/16" x 5-1/2"	18'

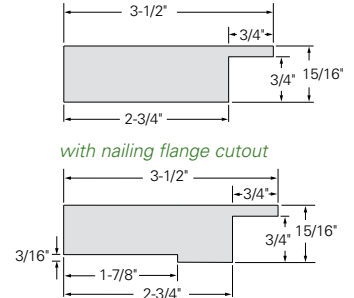

3-1/2" FLAT WITH J

Integrated nailing flange forms a 3/4" J-channel for faster, easier installation.

SIZE	DESCRIPTION	LENGTH
5/4 x 4	3-1/2" Flat with J 1-1/8" x 3-1/2"	16'

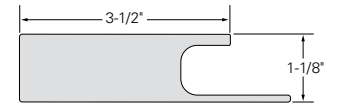

KLEER KONCEAL® CORNERS

A 3/4" reveal makes for easier siding installation and a clean, seamless look.

SIZE	DESCRIPTION	LENGTH
5/4 x 4	Konceal Corner 15/16" x 3-1/2"	10', 20'
5/4 x 6	Konceal Corner 15/16" x 5-1/2"	10', 20'

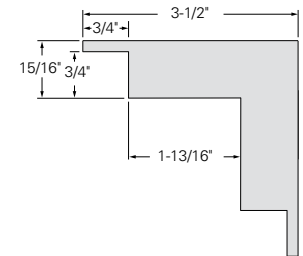

Outside Corner with Integrated Nailing Flange

Integrated nailing flange forms a 3/4" pocket to conceal end cuts.

SIZE	DESCRIPTION	LENGTH
4 x 4	Outside Corner with Nailing Flange 3-1/2" x 3-1/2"	20'
6 x 6	Outside Corner with Nailing Flange 5-1/2" x 5-1/2"	20'

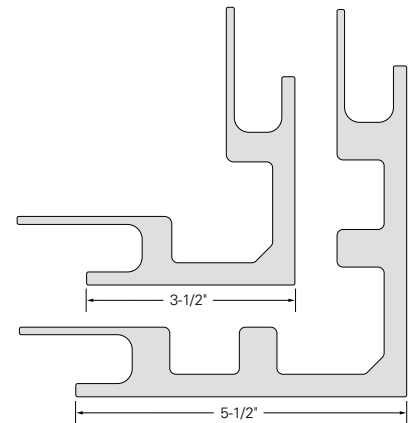

Kleer Corners®

Traditional trim corners are easy to install and offer the aesthetics of true mitered corners, in both smooth and woodgrain finish. Seamless, one-piece construction.

SIZE	DESCRIPTION	LENGTH
5/4 x 4	Kleer Corner 15/16" x 3-1/2"	10', 20'
5/4 x 6	Kleer Corner 15/16" x 5-1/2"	10', 20'

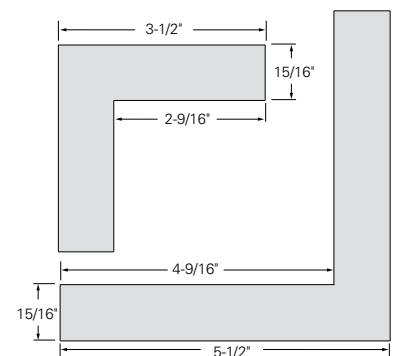

With KLEERWrap®, it's like wooden posts have a protective force field. We're talking superhero-level stuff here.

Made with the same advanced PVC technology as our other products, KLEERWrap Post Wraps encase existing porch posts or columns with a natural wood look that is virtually impervious to moisture and insects. Using Klear PVC adhesives, KLEERWrap Post Wraps can be installed quickly and easily by just one person.

- KLEERWrap Post Wrap comes with two Bed Moulding sets.
- Additional Bed, Crown, Base Cap Moulding and Outer Wrap sets are available separately.
- All KLEERWrap mouldings are mitered and cut to length to fit all KLEERWrap Post Wrap sizes.

POST WRAP



BED MOULDING SETS



BASE CAP MOULDING SET

Available for 4", 6", 8", and 10" post wraps



OUTER WRAP

Available in 5", 7" and 12" lengths for 4", 6", 8" and 10" post wraps



BED MOULDING SET

Available for 4", 6", 8", and 10" post wraps



3-5/8" CROWN MOULDING SET

Available for 4", 6", 8" and 10" post wraps

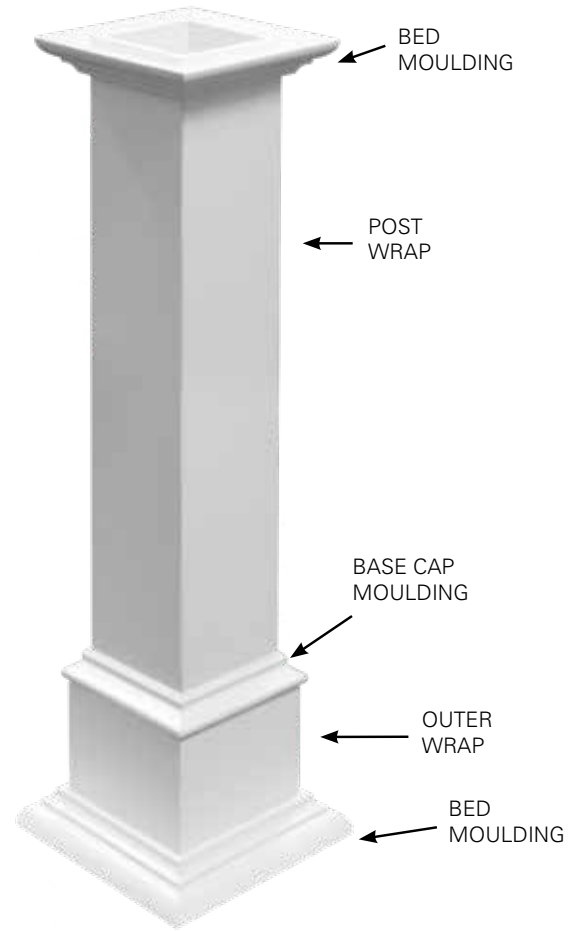

POST WRAP	LENGTHS	ACTUAL INSIDE DIMENSION	ACTUAL OUTSIDE DIMENSION	POST SIZE (NOMINAL)
4"	8', 10'	3-3/4" x 3-3/4"	4-1/2" x 4-1/2"	4" x 4"
6"	8', 10'	5-3/4" x 5-3/4"	6-1/2" x 6-1/2"	6" x 6"
8"	10'	6-1/2" x 6-1/2"	7-1/4" x 7-1/4"	6" x 6"
10"	10'	8-1/4" x 8-1/4"	9-1/4" x 9-1/4"	8" x 8"

OUTER WRAP	LENGTHS	ACTUAL INSIDE DIMENSION	ACTUAL OUTSIDE DIMENSION	ACTUAL THICKNESS
4"	5", 7", 12"	4-1/2" x 4-1/2"	5-1/2" x 5-1/2"	1/2"
6"	5", 7", 12"	6-1/2" x 6-1/2"	7-1/2" x 7-1/2"	1/2"
8"	5", 7", 12"	7-1/4" x 7-1/4"	8-1/4" x 8-1/4"	1/2"
10"	5", 7", 12"	9-1/4" x 9-1/4"	10-1/4" x 10-1/4"	1/2"



Kleer Post Wraps are easy to install on both new construction and remodeling projects.

KLEER BEADED BOARDS

Tell moisture to take a hike.

Bead board is a timeless look for porch ceilings, soffits, bathrooms, laundry rooms and other areas that can be prone to moisture. Kleer bead board products are made from moisture-resistant PVC material, so no matter where and how you use it, you'll get the look you want with a superior level of durability.





KLEERLok® Beaded Boards

This edge-and-center bead profile features a ship-lap nailing flange that increases installation speed and improves the finished look.

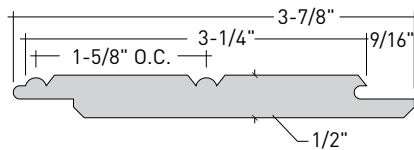

4" KLEERLOK

1/2" x 3-1/4" x 16'
 1-5/8" On-Center Bead
 Reverses to V-Groove
 Tongue and Groove

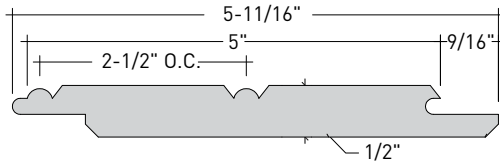

6" KLEERLOK

1/2" x 5" x 16'
 2-1/2" On-Center Bead
 Reverses to V-Groove
 Tongue and Groove

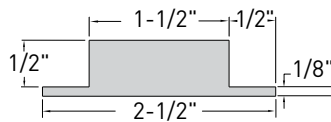

KLEERLOK MOULDING

5/8" x 2-1/2" x 16'
 Used for connecting end joints
 of all Klear Beaded products.

Edge and Center Bead Board

This traditional profile replicates the look of tongue and groove wood planks that's ideal for soffits and other applications.

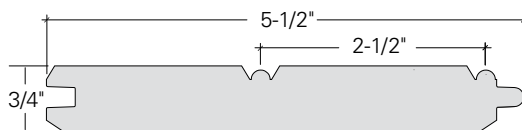

3/4" x 6" x 18'
 Reverses to V-Groove
 Tongue and Groove

KLEERBeed® Beaded Sheets

KLEERBeed Beaded Sheets offer a finished look similar to individual boards, while their larger size makes for fast installation and a consistent surface.

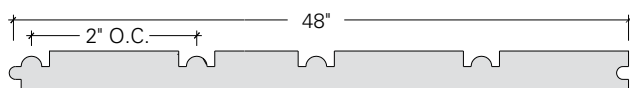

1/2" x 4' x 8'
 1/2" x 4' x 10'
 2" On-Center Bead
 Tongue and Groove

Breaking the mold for mouldings.

Kleer Mouldings offer all the style and elegance of wood, without any of the hassle or costs of high-maintenance products. Its advanced cellular PVC construction makes cutting and installation easier than ever. And realistic patterns and textures provide long lasting beauty, giving any home's interior or exterior that consistent, sophisticated look it deserves.

Window Detail

Sill and drip trim for window applications

LARGE HISTORIC SILL #7435C16

1-25/32" x 2-11/16" x 16'
4 pieces/bundle

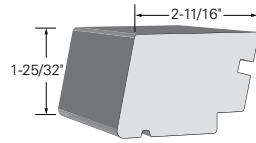

HISTORIC SILL #7650C16

1-3/4" x 2-1/32" x 16'
4 pieces/bundle

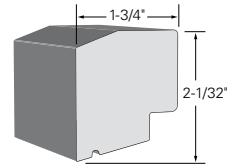

SILL NOSE #5311P16

1-3/8" x 1-5/16" x 16'
8 pieces/bundle

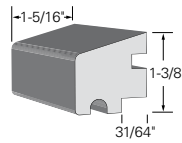

DRIP CAP #5283P16

11/16" x 1-5/8" x 16'
12 pieces/bundle

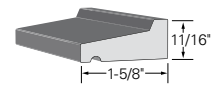

REPLACEMENT SILL #960810Sill

1-1/4" x 7-1/4" x 10'
2 pieces/bundle

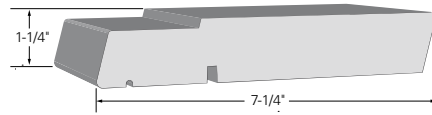

Casing

Surface application around doors, walls and windows.

J-CHANNEL BRICKMOULD #5657P17

1-1/4" x 3" x 17'
6 pieces/bundle

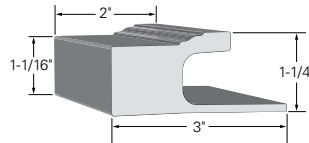

BRICKMOULD #5180P17

1-1/4" x 2" x 17' | 8 pieces/bundle

#5180P18

1-1/4" x 2" x 18' | 8 pieces/bundle

#5180P07

1-1/4" x 2" x 7' | 8 pieces/bundle

#5180P10

1-1/4" x 2" x 10' | 8 pieces/bundle

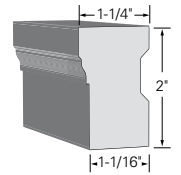

BACK BAND #7931C16

1-11/32" x 1-3/16" x 16'
10 pieces/bundle

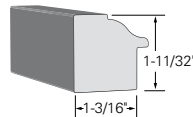

Roofing Detail

Trim for rake and fascia

RAKE MOULDING #5287P16

1-1/16" x 2" x 16'
10 pieces/bundle

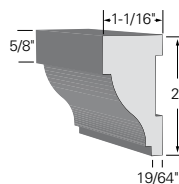

IMPERIAL RAKE #7962C16

1-3/8" x 2-3/4" x 16'
8 pieces/bundle

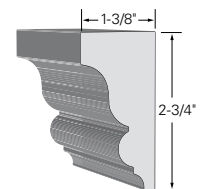

SHINGLE BAND #5210P16

11/16" x 1-5/8" x 16'
10 pieces/bundle

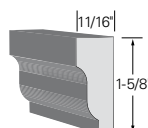

Crown Mouldings

Used at the intersection of walls and ceilings.

7-1/2" CROWN MOULDING #5041C16

1-3/32" x 7-17/32" x 16'
2 pieces/bundle

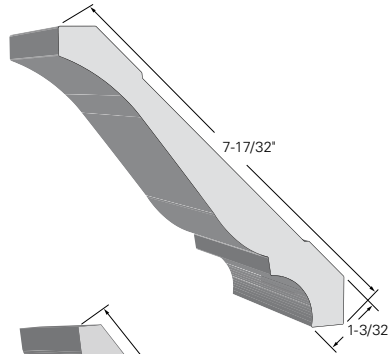

5-1/2" CROWN MOULDING #5045P16

9/16" x 5-1/2" x 16'
8 pieces/bundle

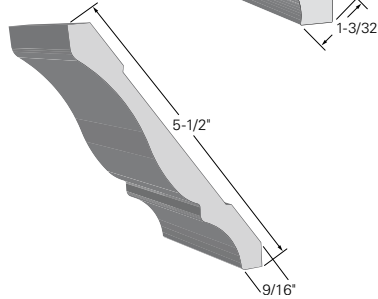

4-5/8" CROWN MOULDING #5047P16

5/8" x 4-5/8" x 16'
11 pieces/bundle

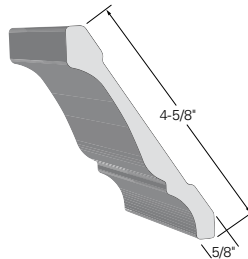

3-5/8" CROWN MOULDING #5049P16

9/16" x 3-5/8" x 16'
10 pieces / bundle

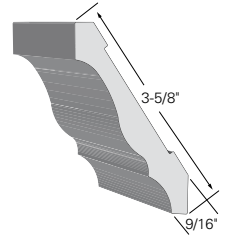

2-3/4" CROWN MOULDING #5063C16

9/16" x 2-3/4" x 16'
10 pieces/bundle

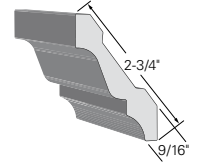

BED MOULDING #5075P16

9/16" x 1-5/8" x 16'
10 pieces/bundle

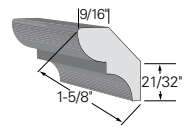

RAMS CROWN #5158P16

1-13/32" x 2" x 16'
6 pieces/bundle

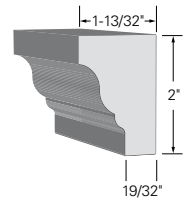

Detail

Additional trim used to accent primary trim.

BASE CAP #5164P16

11/16" x 1-1/8" x 16'
20 pieces/bundle

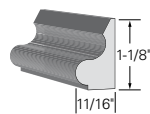

WATER TABLE #5170C18

2-3/4" x 2" x 18'
4 pieces/bundle

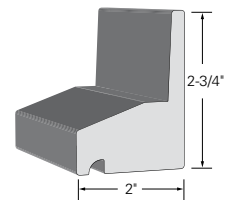

WEATHER STOP #7951C16

3/8" x 1-31/32" x 16'
12 pieces/bundle

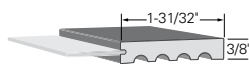

COVE/SCOTIA #5245P16

3/4" x 3/4" x 16'
46 pieces/bundle

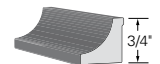

BAND MOULDING #5168P16

5/8" x 1-3/4" x 16'
10 pieces/bundle

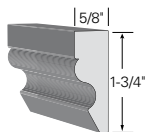

BALUSTER #5150P12

1-1/2" x 1-1/2" x 12'
6 pieces/bundle

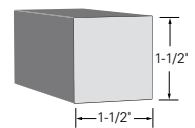

QUARTER ROUND #5234P16

3/4" x 3/4" x 16'
20 pieces/bundle

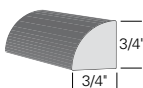

We just love it when building plans come together.

Our adhesives and fasteners have been specially developed to give every Klear project a seamless, finished look. Fill gaps and nail holes and create tight, weatherproof bonds with Klear® Adhesives. The Cortex® for Klear fastening system conceals fastener heads like they don't even exist. If you're using Klear, use Klear Adhesives and Fasteners for a perfect finish every time.

Klear® Adhesives

One adhesive isn't right for every job. That's why we offer both solvent based and two-part adhesives, as well as a structural sealant that performs well beyond standard caulks and nail sticks. Our comprehensive line of Klear Cellular PVC adhesives and sealants make it easy for builders to install Klear boards for a look that will last for years to come. These special adhesives have been formulated precisely for use with Klear Cellular PVC Trim products and are recommended on all Klear projects.

Klear Fasteners®

The fastest, easiest way to hide fastener heads when installing Klear PVC Trim. The finished look of Cortex for Klear PVC trim is virtually invisible and can be painted if desired. ACQ approved.





Kleer Cellular PVC Adhesive

Two-part structural adhesive. 100% waterproof, UV stable, can be sanded and painted, and is color matched to Kleer PVC trim products. It can be used to fill nail holes and gaps up to 1/8" without the need for fasteners or biscuits.

20-25 MINUTE WORK TIME.

Ideal for applications where a slower work time is preferred. 25ml, 50ml, and 220ml cartridges

4-7 MINUTE WORK TIME.

50ml and 220ml cartridges

Kleer Quick Mixer Tips

For use with Kleer Cellular PVC Adhesive. Get the perfect, on-ratio mix each and every time. Designed with a low internal volume for less waste and greater value. 1:1 ratio cartridges for simple and effective application. 24 count.

For 50ml and 220ml cartridges

Kleer Applicator Guns



Used to easily extrude the correct mix of Kleer Cellular PVC Adhesives.

For 50ml and 220ml cartridges

Kleer Caulk Gun Adapter



Used with a standard caulking gun in place of a Kleer 50ml Applicator Gun to extrude the correct mix from a 50ml cartridge of Kleer Cellular PVC Adhesive.

For 50ml cartridges

Cortex® Hidden Fastening System

750 LIN. FT.

1,125 screws, 1,200 plugs, and setting tool. 2" length available in smooth finish. 2-3/4" length available in smooth or woodgrain finish.



250 LIN. FT.

375 screws, 400 collated plugs, and setting tool. 2" and 2-3/4" lengths available in smooth or woodgrain finish.



50 LIN. FT.

75 screws, 100 plugs, and setting tool. Smooth or woodgrain finish.



Kleer Cellular PVC Laminating Adhesive

A two-part structural adhesive. Lower viscosity for enhanced "flow-out." Requires less clamping pressure for a thin, void-free bond when laminating cellular PVC faces together to create thicker pieces.

220ML cartridges



Kleer PVC Cement

A superior quality, fast-drying adhesive that creates a strong yet flexible bond and provides outstanding resistance to weather and temperature extremes. Color matched to Kleer PVC trim products.

4 oz. tube

4 oz., 8 oz., and 16 oz. cans with built-in applicator brushes



Kleer Cellular PVC Cement Thinner

Used to change viscosity or to reactivate dried Kleer Cellular PVC Cement.

16 oz. can



Kleer Cellular PVC Nail Stick

A two-part epoxy putty used for filling nail holes in PVC.

Cures off-white to light grey. Sand it, drill it and paint it to make a great finish for any installation.



Kleer Structural Sealant

A multi-purpose product. Its tenacious adhesion and elastomeric properties make it the ideal product for filling expansion gaps and filling nail holes. It skins over quickly and can be painted in 2 hours, with a full cure time of roughly one week.



If time is money, you're about to cash in.

Our high-quality products minimize callbacks and returns due to manufacturing defects that can slow your projects down. We also have a number of programs to help reduce your costs and grow your business.

Sales Support

At Klear, we pride ourselves in developing relationships with our builders, contractors and architectural customers that help them build their businesses for years to come. Our in-market sales team will work side-by-side with you to make sure our products get you the best possible results.



KleerBucks and Rebate Programs

If you're a first-time customer or long-time loyal customer you can get a rebate back for purchases made on Kleer products.

Model Home Program

Building a model home? You can get a credit on Kleer purchases used on your model home.

Architect Meetings

Westlake Royal Building Products holds regular virtual and in-person architect meetings to provide vital information and demos for different building materials. As a registered provider with The American Institute of Architects Continuing Education Systems, attendees can earn AIA credits upon completion of this program.



Who would have thought trimboard could be a property manager's best friend?

The single biggest issue with managing multi-family properties is maintenance costs. Reduce them and you can increase your profitability. Kleer products are easy to install, similar to wood, and can be put up quickly with low maintenance and few callbacks. They also won't rot or fade, and because they don't need to be painted, they won't need to be repainted again and again. Kleer can be combined with a wide range of building products, especially other specialty siding, shutters and accessories from Westlake Royal Building Products. Build your multi-family properties for the long run with Kleer.

MULTIFAMILY



STAY CONNECTED

Get the latest from Westlake Royal Building Products

Follow us on Facebook, Twitter and Instagram for ideas and inspiration on how you can use Kleer and other products from Westlake Royal Building Products.

We want to see what you've been up to.

We're always impressed by what contractors can do with our trimboards, wraps, bead boards and mouldings. We want to see your handiwork. When you use Kleer on a project, snap a picture and share with us on our social channels. We'll share it with all our followers and give you credit for a job well done.

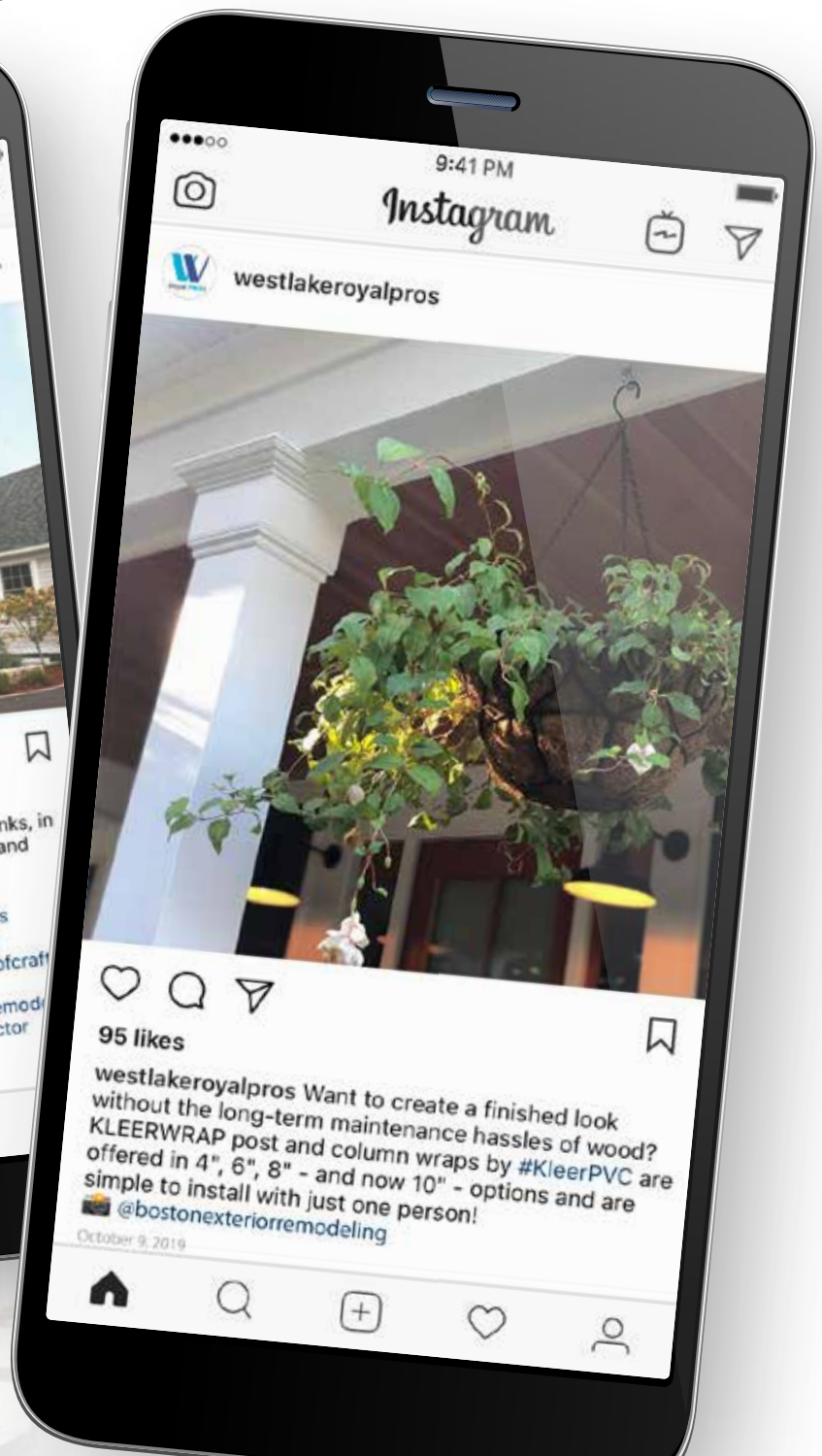



KleerLumber.com
800.521.8486



NAHB
NATIONAL ASSOCIATION
OF HOME BUILDERS



NARI
NATIONAL ASSOCIATION OF
THE REMODELING INDUSTRY



CAD details



Intertek

CODE
COMPLIANCE
CCRR-0237

Westlake
Royal Building Products™
WestlakeRoyalBuildingProducts.com

© 2022 Westlake Royal Building Products

SIDING & ACCESSORIES
TRIM & MOULDINGS
ROOFING
STONE
WINDOWS
OUTDOOR LIVING

KL036 | K30048341 2/22