

ENGLISH VERSION

"DISTINCTION" - METAL CLADDING (TYPICAL SUGGESTED WALL COMPONENTS)

- "DISTINCTION" METAL CLADDING
- METAL FURRING GALV. 16 GA @ 16" C/C OR
WOOD FURRING 1" X 4" @ 16" C/C
- AIR BARRIER / VAPOR BARRIER MEMBRANE ,
WITH NAILS' SEALING CAPACITY (3M 30/15 VP OR EQ.)
- WOOD BRACING AND/OR RIGID INSULATION
COVERING THERMAL BRIDGES
- BATT INSULATION
- STEEL OR WOOD STUD @ 16" C/C
- VAPOR BARRIER
- STEEL OR WOOD FURRING
- INTERIOR FINISHING



CADD BY: G.L.
DATE: NOV. 21, 2018
APPD. BY: J.D.G.
REV. No: 3

TITLE: TYPICAL ASSEMBLY

DETAIL: 1
CAD FILE: "DISTINCTION" WALL HORIZONTAL CLADDING

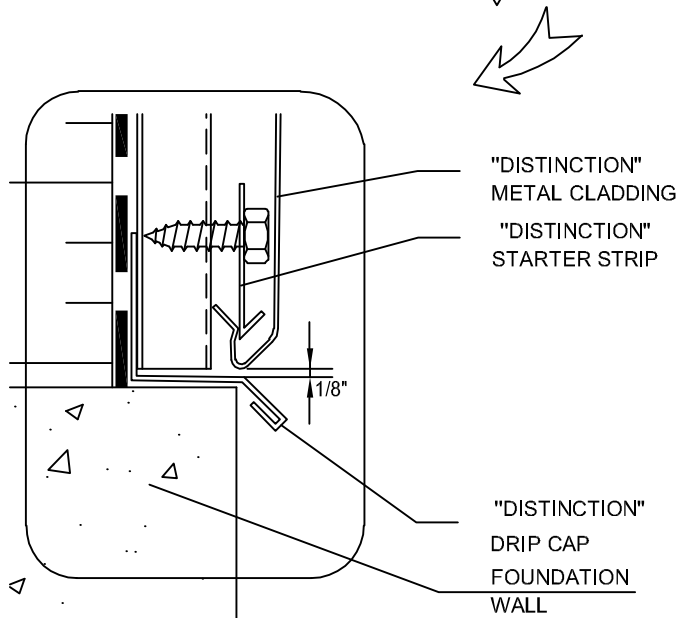
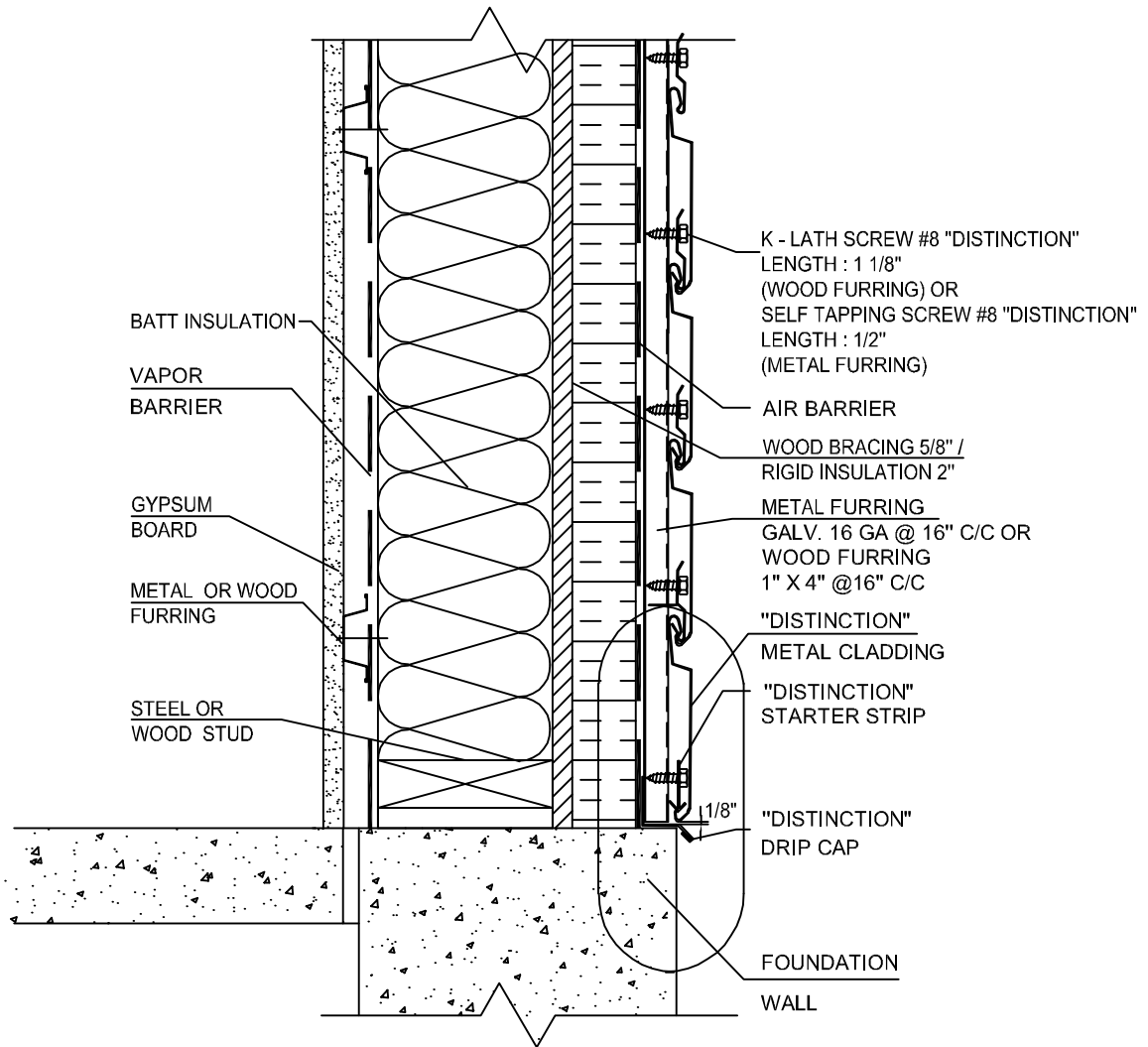

CADD BY: G.L.
 DATE: NOV. 21, 2018
 APPD. BY: J.D.G.
 REV. No: 3

TITLE:
**FOUNDATION WALL TO
 "DISTINCTION" CLADDING
 DETAIL - SECTION**

DETAIL:
2
 CAD FILE:
 "DISTINCTION" WALL
 HORIZONTAL CLADDING

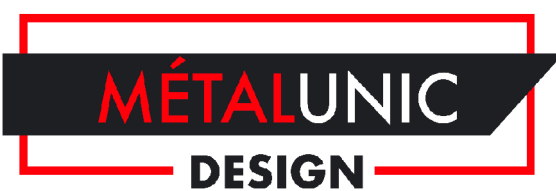
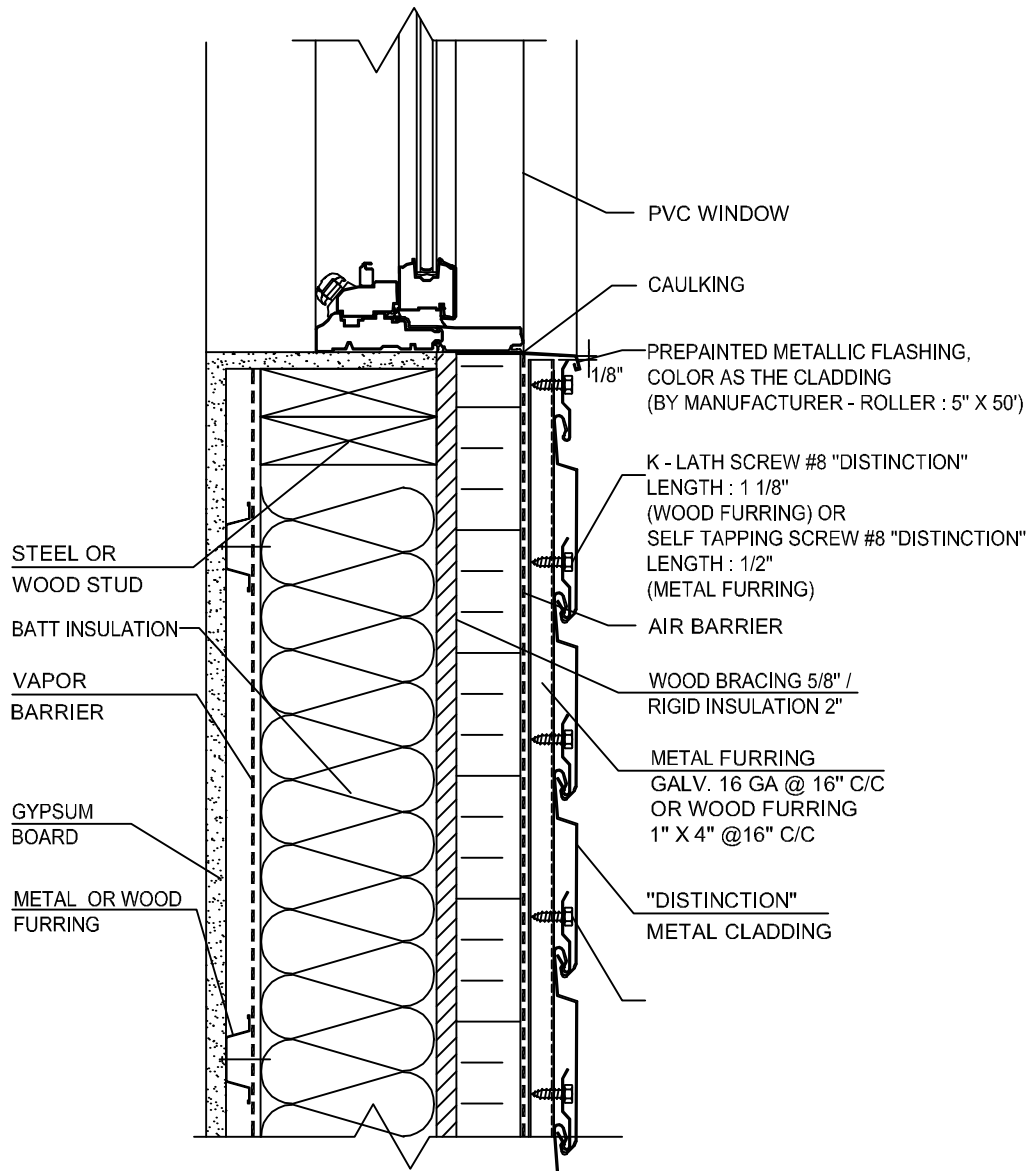

CADD BY: G.L.
DATE: NOV. 21, 2018
APPD. BY: J.D.G.
REV. No: 3

TITLE: WINDOW SILL DETAIL - SECTION

DETAIL: 3
CAD FILE: "DISTINCTION" WALL HORIZONTAL CLADDING

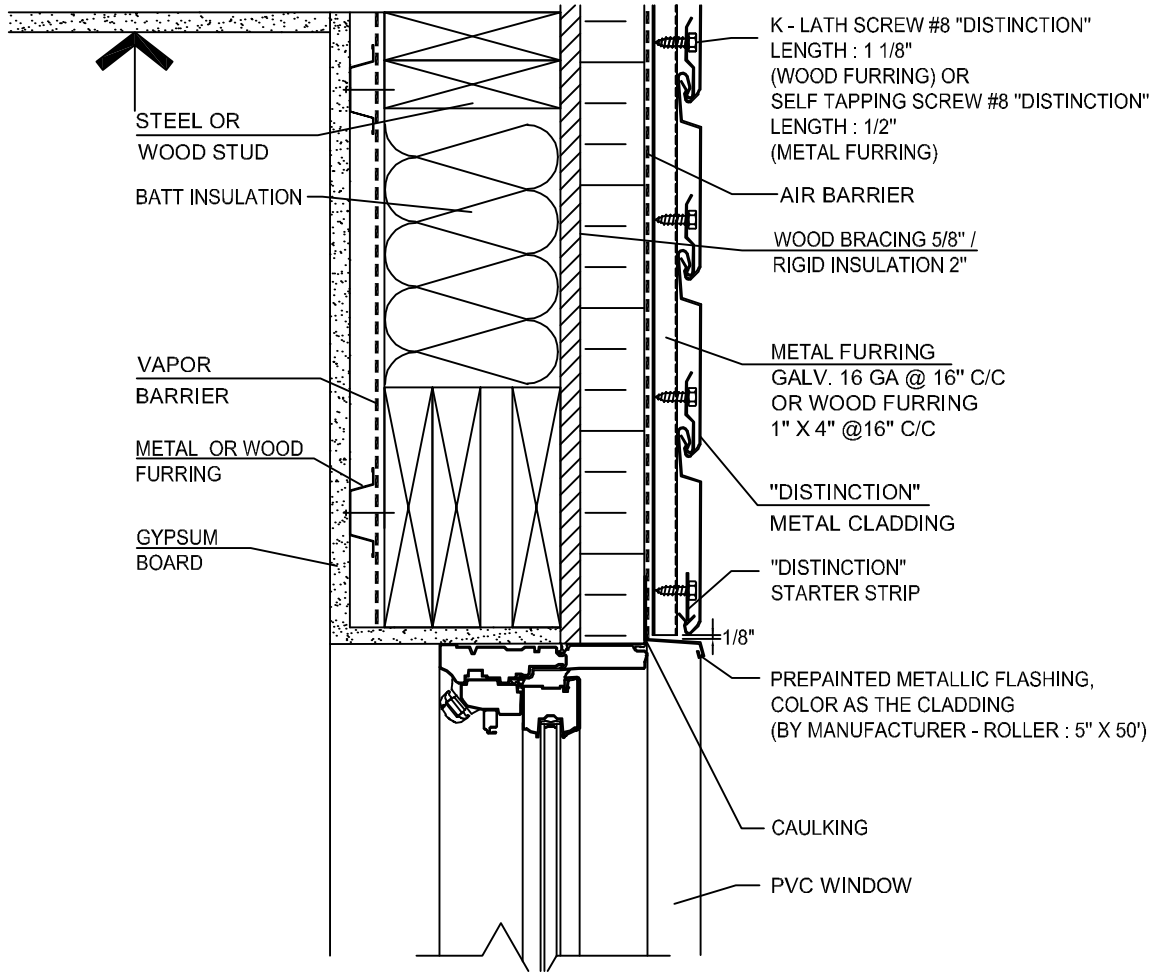

CADD BY: G.L.
DATE: NOV. 21, 2018
APPD. BY: J.D.G.
REV. No: 3

TITLE: WINDOW HEAD DETAIL - SECTION

DETAIL: 4
CAD FILE: "DISTINCTION" WALL HORIZONTAL CLADDING

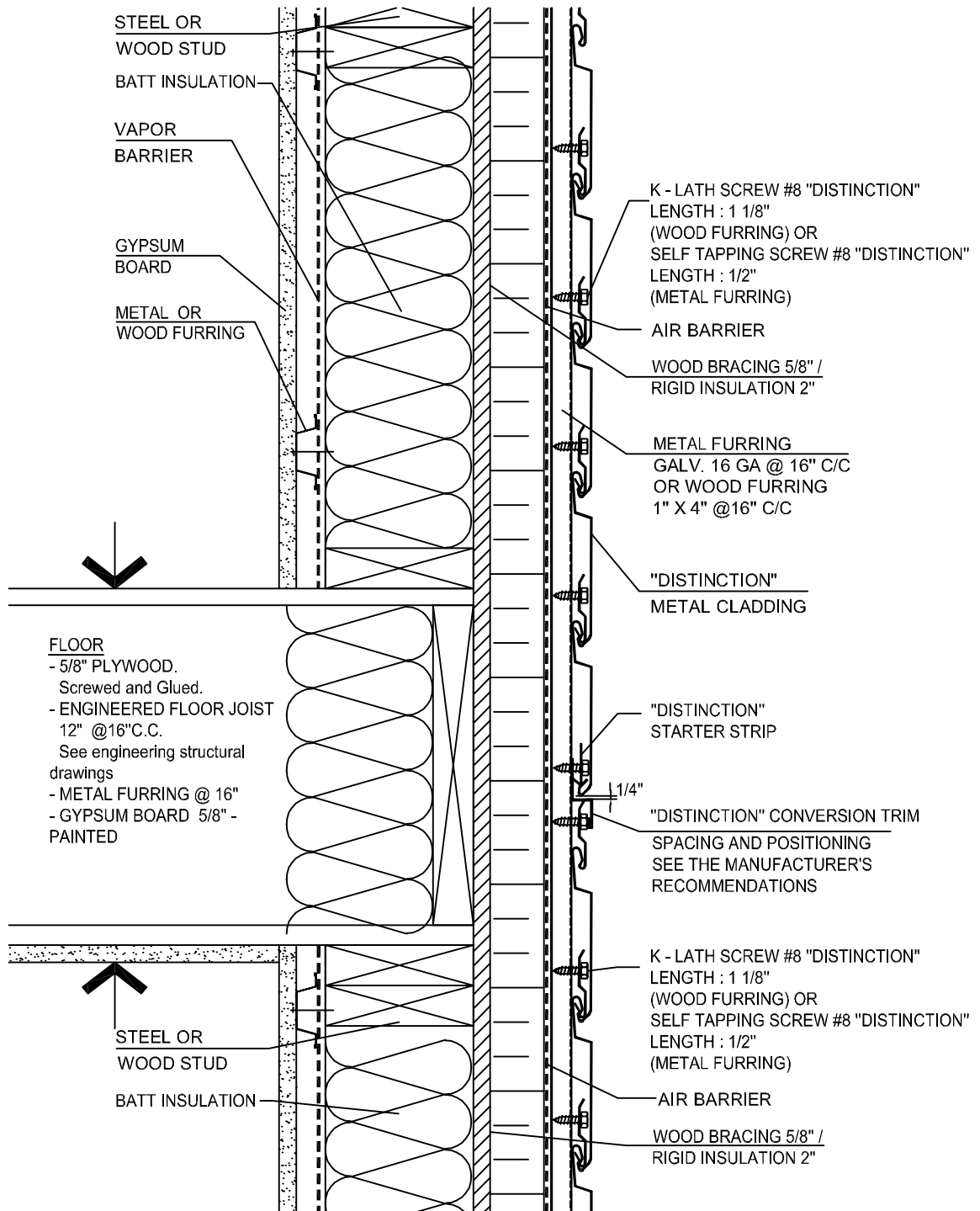

CADD BY: G.L.
 DATE: NOV.21,2018
 APPD. BY: J.D.G.
 REV. No:3

TITLE:
**EXPANSION JOIN BETWEEN LEVELS
 DETAIL SECTION**

DETAIL:
5
 CAD FILE:
 "DISTINCTION" WALL
 HORIZONTAL CLADDING

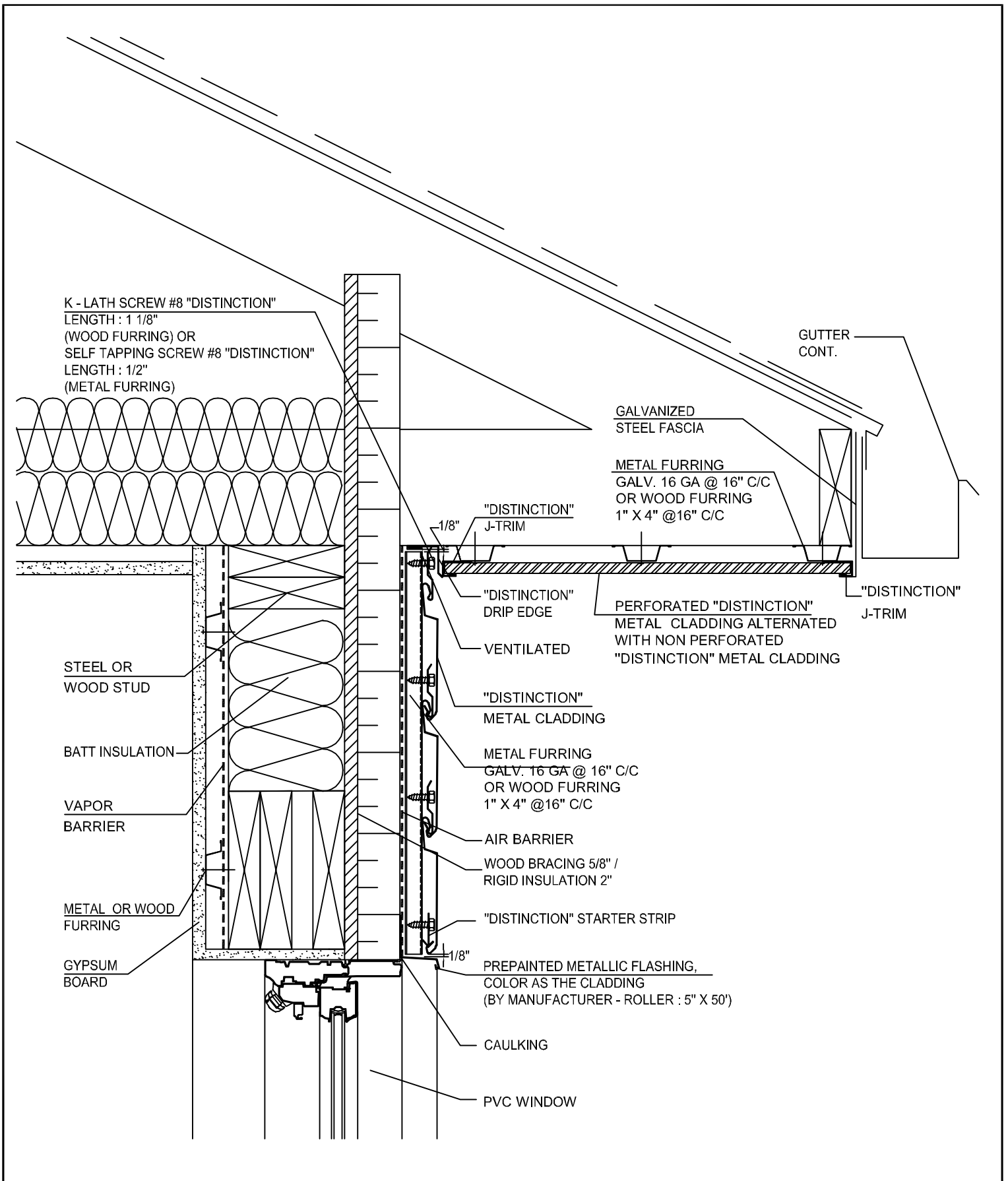

CADD BY: G.L.
 DATE: NOV. 21, 2018
 APPD. BY: J.D.G.
 REV. No: 3

TITLE:
**ROOF
 DETAIL - PLAN**

DETAIL:
6
 CAD FILE:
 "DISTINCTION" WALL
 HORIZONTAL CLADDING

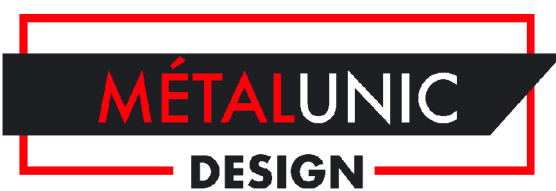
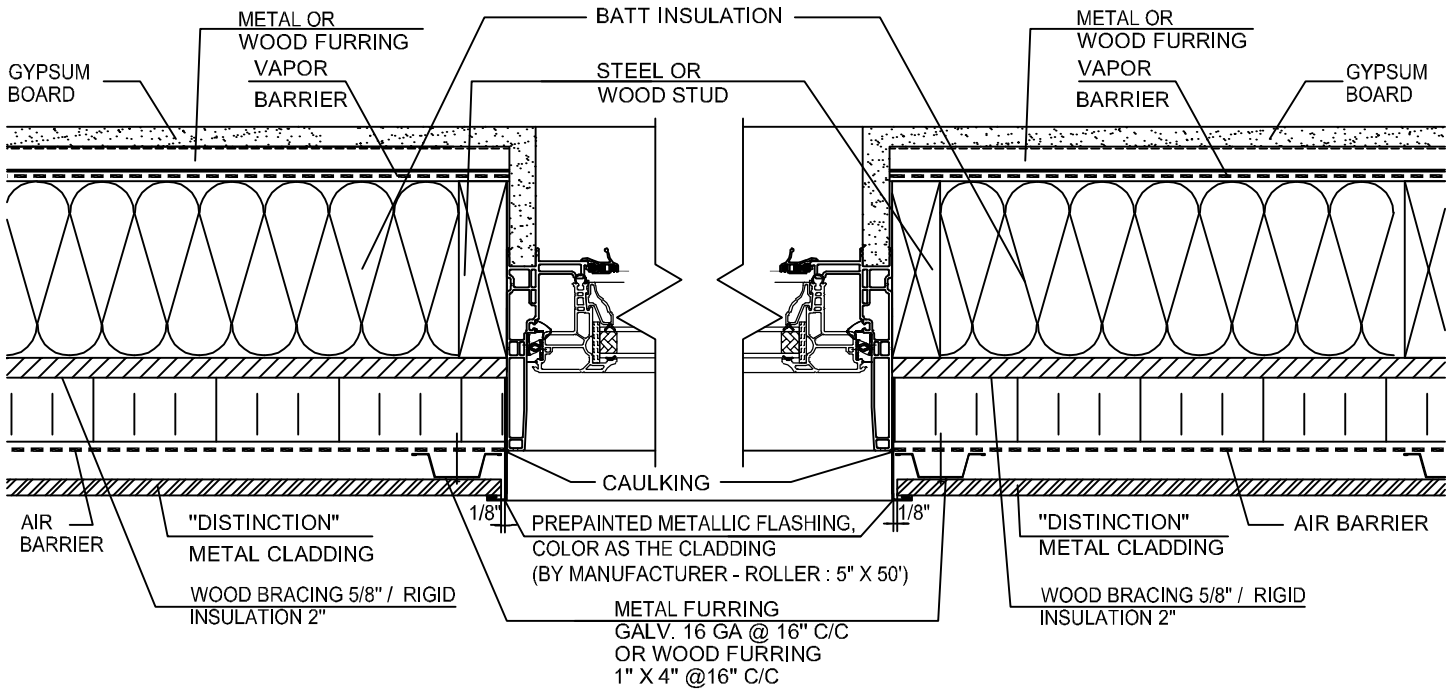

CADD BY: G.L.
 DATE: NOV. 21, 2018
 APPD. BY: J.D.G.
 REV. No: 3

TITLE:
**WINDOW JAMB
 DETAIL - PLAN**

DETAIL:
7
 CAD FILE:
 "DISTINCTION" WALL
 HORIZONTAL CLADDING

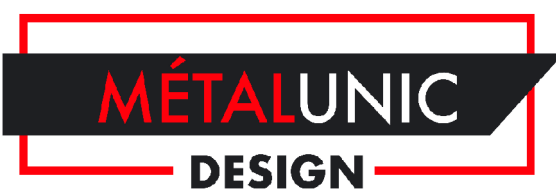
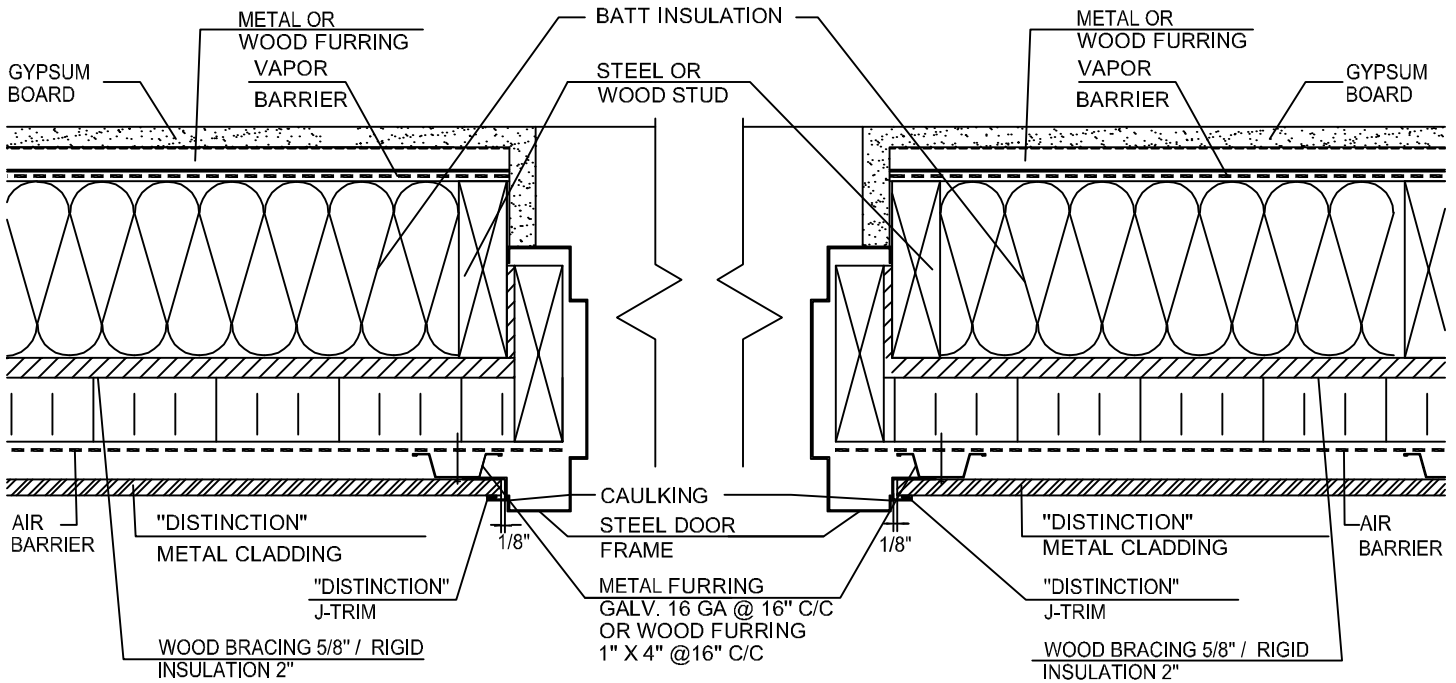

CADD BY: G.L.
 DATE: NOV. 21, 2018
 APPD. BY: J.D.G.
 REV. No: 3

TITLE:
**DOOR JAMB
 DETAIL - PLAN**

DETAIL:
8
 CAD FILE:
 "DISTINCTION" WALL
 HORIZONTAL CLADDING

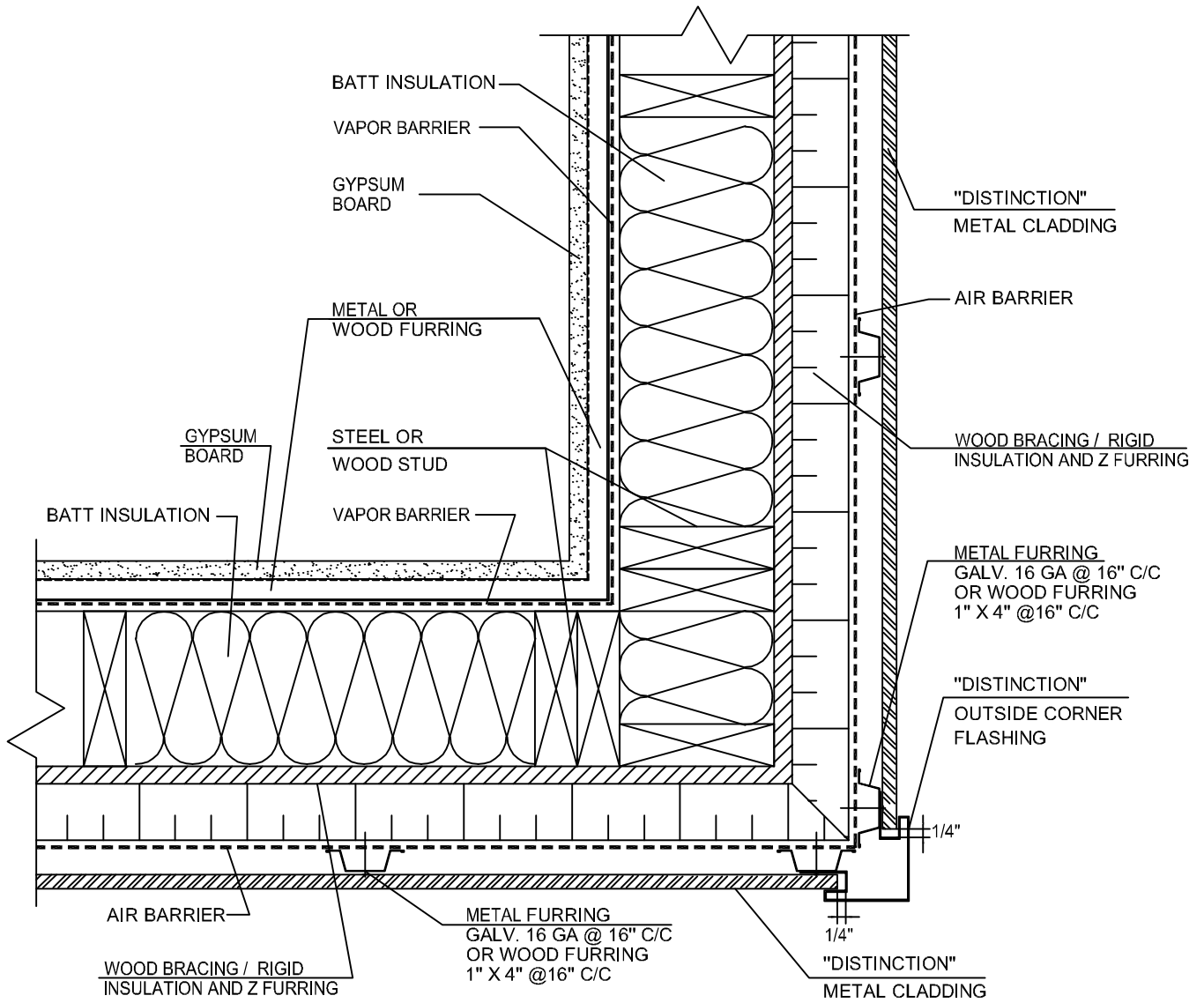

CADD BY: G.L.
 DATE: NOV. 21, 2018
 APPD. BY: J.D.G.
 REV. No: 3

TITLE:
**OUTSIDE CORNER WALL
 HORIZONTAL CLADDING
 DETAIL - PLAN**

DETAIL:
9
 CAD FILE:
 "DISTINCTION" WALL
 HORIZONTAL CLADDING

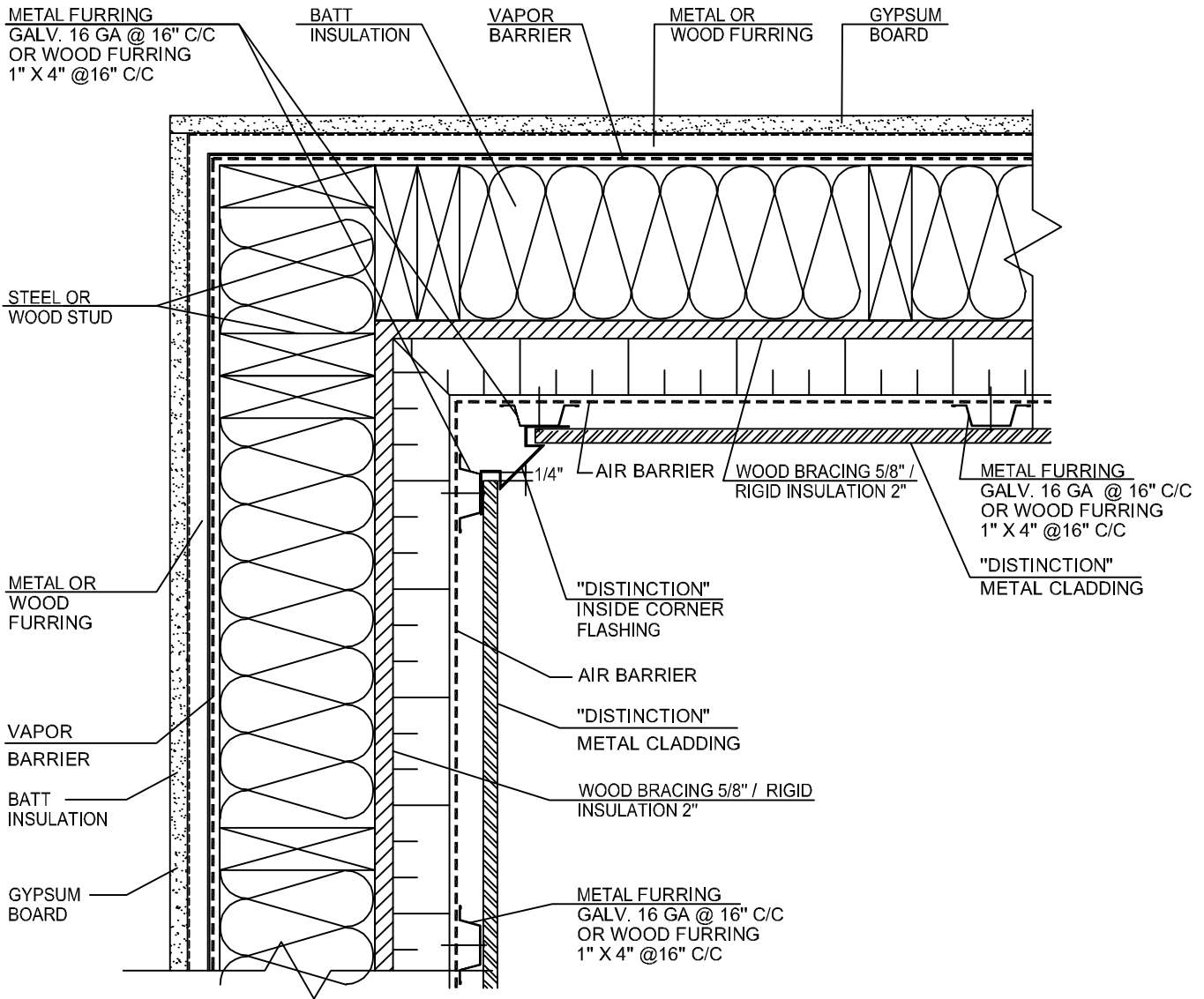

CADD BY: G.L.
DATE: NOV. 21, 2018
APPD. BY: J.D.G.
REV. No: 3

TITLE:
**INSIDE CORNER WALL
HORIZONTAL CLADDING
DETAIL - PLAN**

DETAIL:
10
CAD FILE:
"DISTINCTION" WALL
HORIZONTAL CLADDING