

TONGUE & GROOVE PLANKS

INTERIOR WALL SYSTEM

OCT 2022

the DOUGLAS

TYPICAL ISOMETRIC

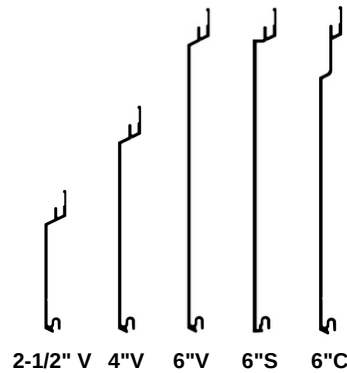
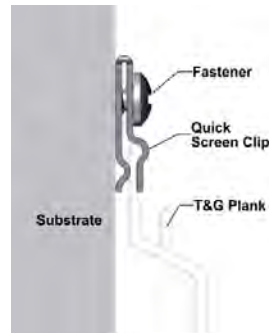

PROFILES

V-Groove: 2-1/2", 4", 6"
Smooth: 6"
Channel: 6"
Standard Lengths: 24'
96 SQ FT/box

COMPONENTS - Standard Lengths: 12'

Traditional: Starter Strip, 2" Corner Set, 1-3/8" Two Piece J-Track, 1-3/8" Termination Set, Compression Joint (24'), 1-1/2" Flat Reveal Set, 1-1/2" U-Reveal Set, 1-1/2" T&G U-Reveal, 2" Offset Flat Reveal

Craftsman: 3/4" Inside Corner, 1" Outside Corner, 3/4" U-Reveal Set, 3/4" T&G U-Reveal

Precision: 5/8" Starter J-Track, 3/16" Outside Corner, 5/8" J-Track, 5/8" Two Piece J-Track, 5/8" Termination Set, 1/2" Flat Reveal, 1/2" T&G Flat Reveal

FINISHES

Woodgrains, solid color, naturally aged metal, custom solid colour matching (additional lead times apply)

ATTACHMENT

Planks: Quick-screen clips w. #8 screws* @ 32" o.c. (standard).
Quick-screen clips included: 135 pcs/4" box, 90 pcs/6" box.
Trims: hard fasten w. #8 screws* @ 16" o.c. *Screws not included.

BIM & CAD

RVT & DWG files available, see website for details

LEAD TIME

3-6 business days + shipping (subject to change)



info@longboardproducts.com
longboardproducts.com
800 604 0343

TECHNICAL SPECIFICATIONS

PHYSICAL DATA

6063-T5 Extruded Aluminum
100% Recyclable
Warranty: Finish:15 year (standard)/20 year* (ultra) (*10 week lead time);
Aluminum: 50 year
Weight (lbs/sqft): ~1.5

TESTING

ICC-ES Evaluation Report - Division: 07 00 00 Thermal and Moisture Protection
Section: 07 46 00 - Siding

LARR - Los Angeles Department of Building Safety (LADBS) accepts ICC-ES reports as proof of compliance

Florida Product Code: FL20075

Impact testing: TAS 201



Fire Rating: Class A Non-Combustible by ASTM E136 & ASTM E84 ; A2-s1,d0 by EN 13501-1



Light Reflectance: 5% (Black) up to 73.2% (Ultra White)



LONGBOARD®
ARCHITECTURAL PRODUCTS

Interior

Tongue and Groove Walls

Installation Guidelines

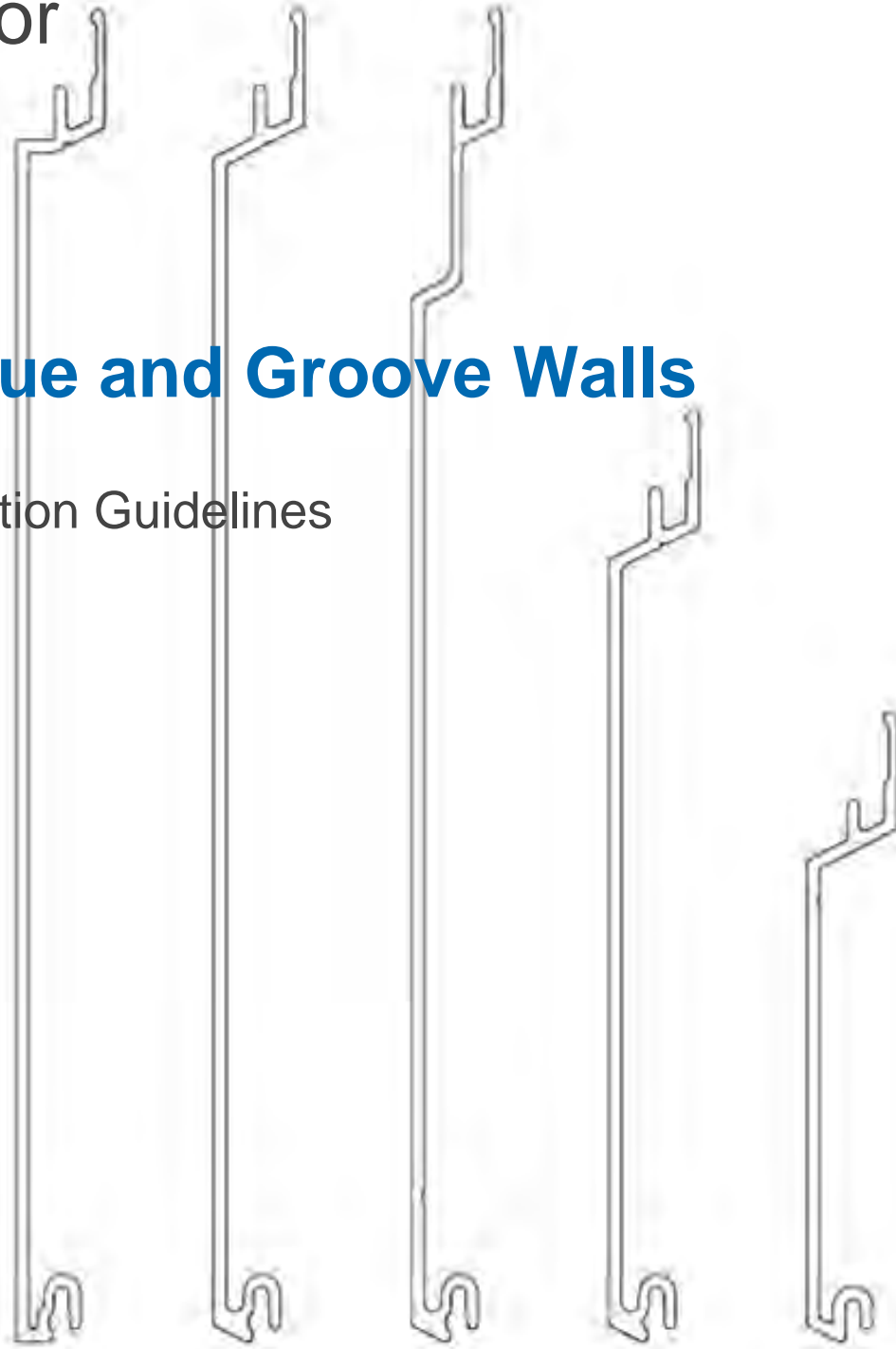

Table of Contents

<u>Product Description</u>	<u>3</u>
<u>Material Specifications</u>	<u>3</u>
Surface finishes	3
Expansion and contraction	3
Material ordering and deliveries	4
Storage and handling	4
Cleaning	4
Warranty	4
<u>Components/Tools</u>	<u>5</u>
Tools/equipment and hardware	5
Component images and descriptions	5
<u>System Install</u>	<u>6</u>
Install considerations	6
Install techniques/tips/details	6-8
Cutting	9
Fastening	9
Fastener types	9
Framing requirements	10
System layout	11
Perimeter and field area limitations	11
Install perimeter components	12
J-Track	12
Termination Set	12
Starter Strip	12-13
Corners	14
Install field components -Floor elevations	15
Install field components -Exp. Reveal	16
Install plank components	17
Horizontal plank steps	17-18
Vertical plank steps	19-20
Final Steps	21
<u>Appendix</u>	<u>22</u>
Tables - Expansion & contraction	22
Tables - Quick Screen clip/wind load	23
Handling and care of products	24
Blank page	25
Contact Info	26

Product Description

Longboard® architectural products are extruded aluminum systems for high performance building facades and decorative elements. These streamlined systems are integrated with existing building materials and designed for many applications. Longboard encompasses a naturally beautiful finish while providing a premium quality material designed to be installed horizontally or vertically. Longboard products are available in standard lengths and widths for typical styles of cladding and specific architectural products.

Material Specifications

Surface Finishes

Longboard Products are available in a wide range of woodgrains and solid colors varying in color and tone to suit your aesthetic look. Custom solid colors are available upon request.

Longboard woodgrains have a repeat pattern, shipped in sets mated back-to-back in each box. Install these as they come out of the box, as an A&B pattern staggering each plank approx. 1-2' (305-610mm) from the previous plank to achieve a random pattern aesthetic.

All Longboard Products are produced 1" (25mm) oversized, as one end is drilled for the coating process and both ends have 1/2" (12mm) of masking tape (woodgrains only) which must be cut off for best results.

Expansion & Contraction

Planks & components expand & contract 1/4" (6mm) over 24' (7.3m) in all directions, measured over a 30°C (54°F) temperature range. Due to this range of movement, the following expansion components should be installed parallel and perpendicular every:

Horizontal Install

- 24' (7.3m) max^{1 2} Perpendicular to Planks: Traditional Flat Reveal Set, Traditional U-Reveal Set
Parallel to Planks (at each floor elevation): Compression Joint

Vertical Install

- 24' (7.3m) max² Parallel and/or Perpendicular to Planks: Traditional Flat Reveal Set, Traditional U-Reveal Set, J-Tracks back to back

¹Note: 40' (12.2m) max if using staggered butt-joints.

²Note: Through-wall flashing (where required) at every floor elevation.

Other options (Perpendicular to Planks only)

- 12' (3.7m) -Craftsman U-Reveal Set
- 6' 8" (2m) -Precision Flat Reveal

When using expansion components, each plank must terminate into a minimum of one (1) component to allow for expansion & contraction.

See: Appendix for tables of expansion/contraction calculations per foot/meter of material.

Material Ordering & Delivery

- Packaging: Planks are sold in box quantities:
6" V-Groove, 6" Channel & 6" Smooth: 96 SQ FT/Box (8/24's) w. 90pcs Quick-Screen Clips included
4" V-Groove: 96 SQ FT/Box (12/24's) w. 135 Quick-Screen Clips included
Components are sold individually by the 12' (3.7m) length.

- Shipping: Lead time is 3-6 business days* + shipping (**subject to change*), delivered on 24' (7.3m) long skids weighing up to 2000 lbs. A mechanical lift with forks is required on site to receive the order.

- QC: Always inspect the delivery for damage and contact LB ASAP if there are any issues: info@longboardproducts.com or 1-800-604-0343 and include your PO# and any pictures if possible. Mark the delivery receipt as "damaged" and accept the delivery as-is. Longboard is not responsible for the installation of blemished or damaged material.

Storage & Handling

Be sure to store the material flat, keep it dry, safe & secure and remain in unopened cartons until ready to be installed.

See Appendix for proper handling and care instructions.

Cleaning Recommendations

While Longboard finishes require zero maintenance, we do recommend periodic cleaning to keep the product looking its best. Our finish is tested to withstand corrosion, fading and normal wear, however, neglect and rough conditions could have negative effects on the surface finish. Your Longboard products should be cleaned immediately after installation. See the cleaning guide for our suggestions based on soil level. Basic methods use a combination of moderate water pressure, soft sponge/brush and a mild detergent.

see *Cleaning Guide for full requirements: longboardproducts.com

⚠ NEVER use aggressive acid or alkaline cleaners on Longboard finishes. Do not use cleaners containing Trisodium Phosphate, Phosphoric Acid, Hydrochloric Acid, Hydrofluoric Acid, Fluorides or any other compound that is known to react with metal.

Always follow the product instructions for dilution. Cleaning the surface with a cleanser that is not diluted may result in damage to the coating.

Warranty

Upon substantial completion of the project, register for warranty online here: longboardproducts.com/warranty

⚠ Registration is required for the warranty to be in effect.

Components/Tools

Tools/equipment/hardware

Use standard wood-cutting tools such as a Table Saw & Miter Saw with a carbide blade (60-80 tooth) for non-ferrous metals (aluminum), Jig Saw, Hole-Saw & drill for attachments.

Recommended to use standard 2" - #8 panhead screws supplied by the installer.

Component images and descriptions (Typical)

Longboard systems consist of many components used in conjunction with each other to create a dynamic seamless look. For all LB components go to longboardproducts.com.

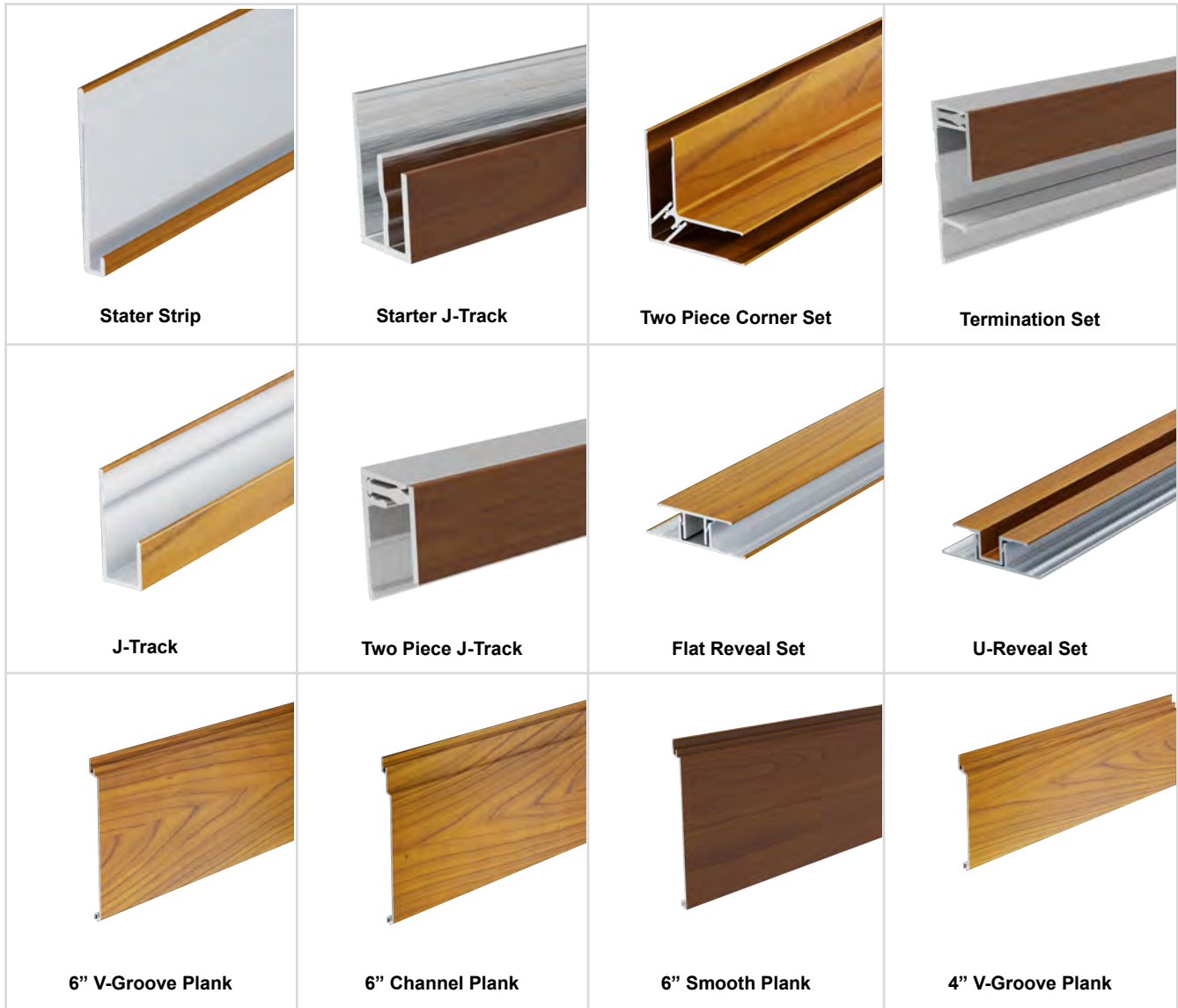

System Install

Installation considerations

- Longboard system typical dimensions:
 - Planks and components total depth - 9/16" (15mm)
 - Planks - 1/2" (12mm)
 - Curved walls: - 15' (4.6m) min radius
(tighter radii contact Longboard)
- Longboard Products are not recommended for use on marine applications in direct contact with salt water.
- Longboard Cladding is to be installed outboard of a weather resistant barrier, including all flashings, following code and building requirements.

Install techniques/tips/details

- It is good practice to leave a 1/4" (6mm) gap between every 2nd perimeter component joint or 24' (7.3m) to allow for expansion & contraction. Consider the joints where components meet each other to dictate which component is installed first (eg: right angle butt joints, mitered joints etc.).
- Quick-Screen Clips allow for free movement of the planks, to expand & contract during thermal changes.

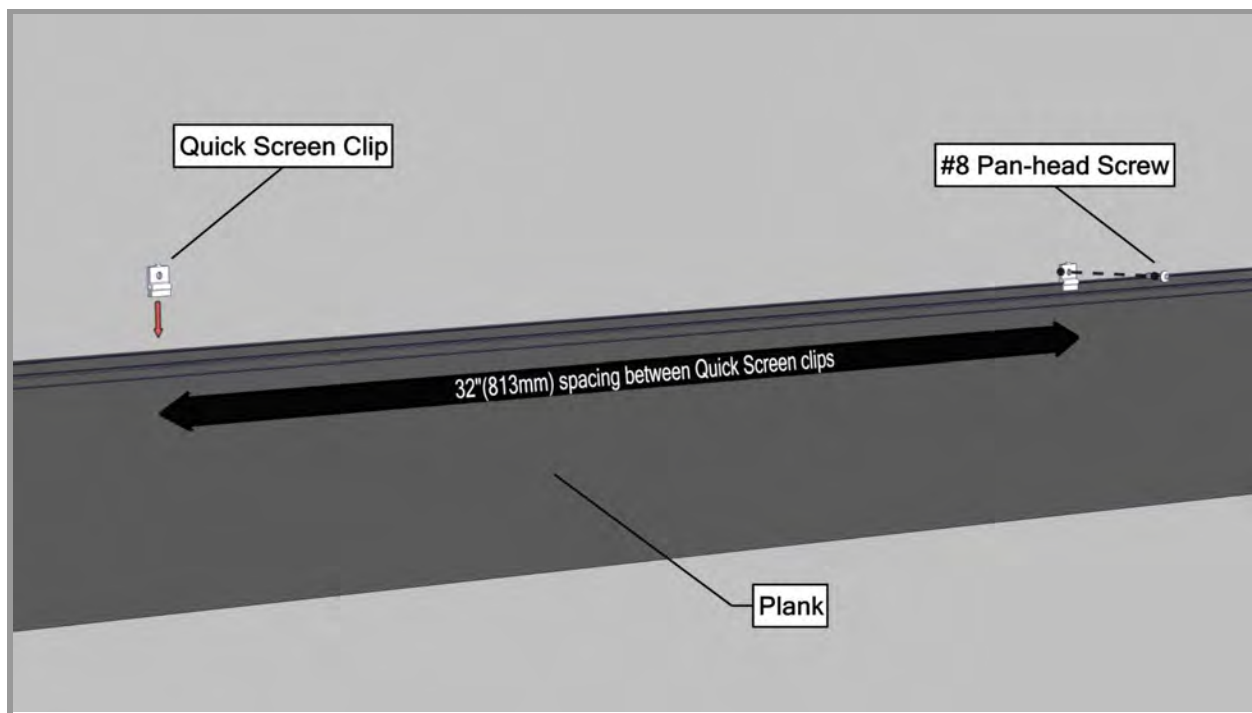

- **⚠ BUTT-JOINTS.** When installing staggered butt-joints, hard-fasten the two planks at the butt-joint to ensure joints do not open up (**See Detail A, B & C**). Fasteners should be anchored into a solid secure framing member, blocking, furring strip or backer plate, etc.
- If needed, use touch-up paint pens (purchased separately) to finish the ends of the two (2) planks at the butt-joint.
- DO NOT install more than one (1) butt-joint between two components
- DO NOT hard-fasten a plank to a component trim (except Precision outside corner), as this will restrict its ability to expand & contract into the component.
- If no butt joints along the length, it is good practice to hard-fasten each plank directly through the flange near the center, to keep the planks from migrating.
- *When using the Precision Outside Corner, miter the end of the Planks to fit tight to the Corner. Secure by hard fastening at the mitered end into the flange of the Corner to ensure joints do not open up.
- Butt-joints are not permitted when using the Precision Components, and components should be installed every 6' 8" (2m) max.
- DO NOT hard-fasten more than one (1) location per plank.
- Fasten only:

Situation	Location
No butt-joints:	-Center of planks
Butt-joints:	-At the joints
*Precision Outside Corner w/no butt joints:	-At the Corner

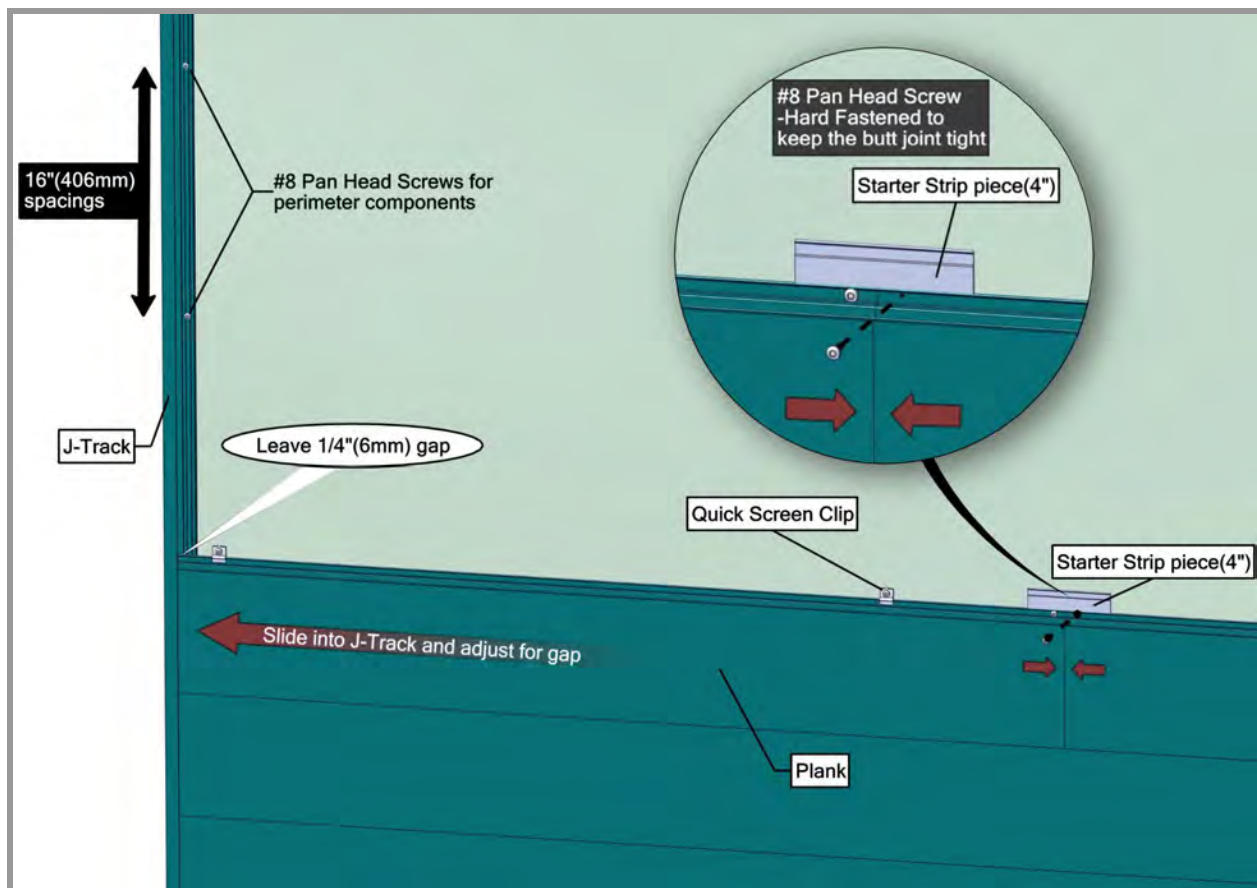

Detail A

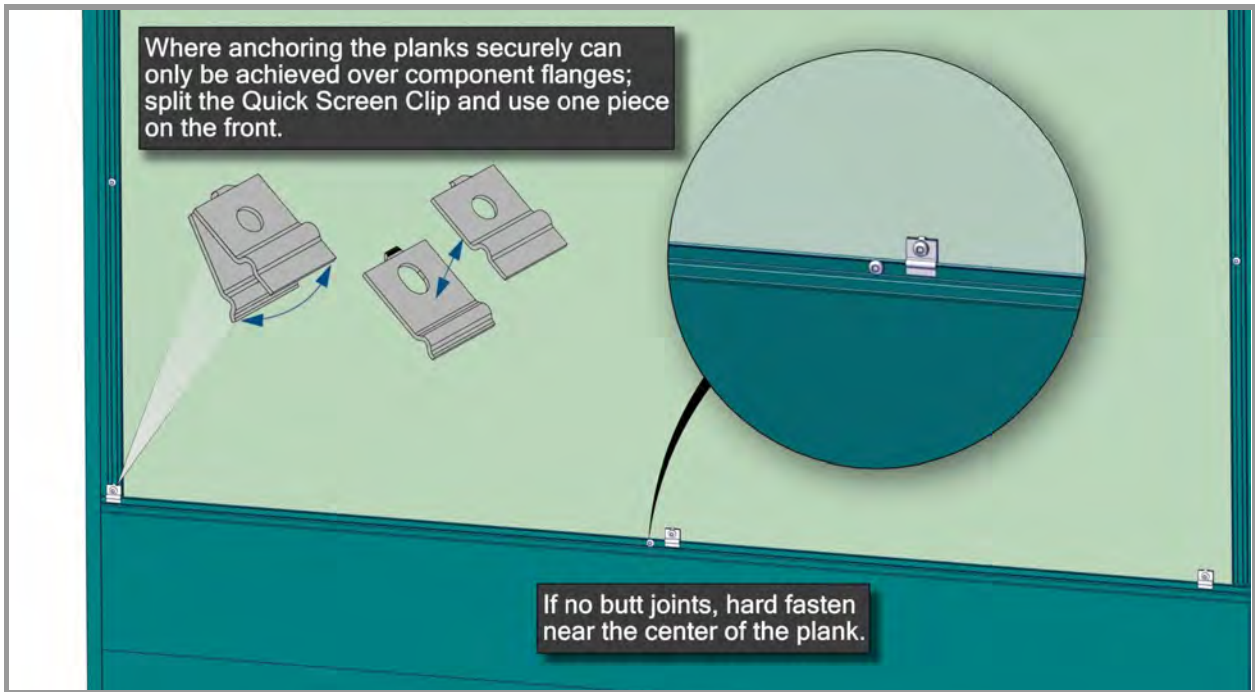

Detail B

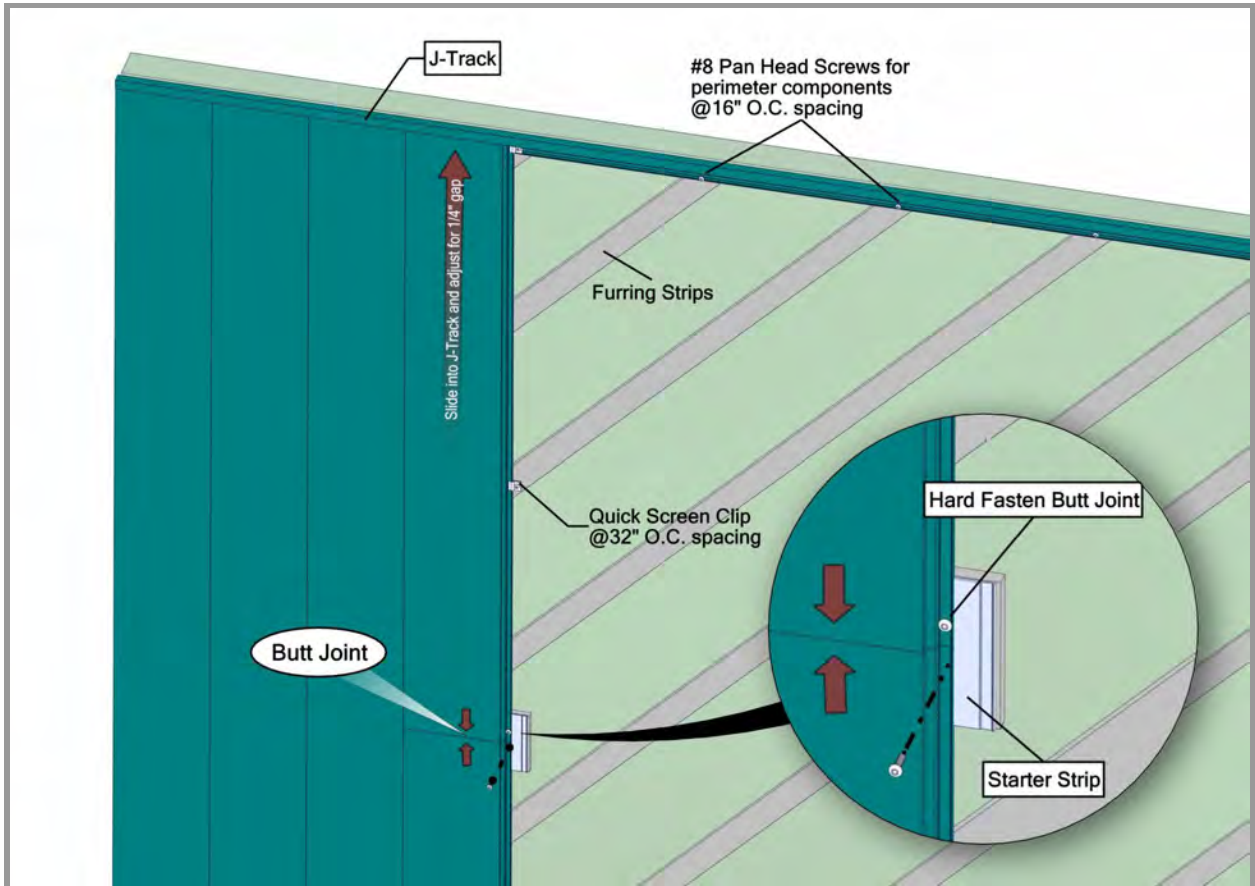

Detail C

Cutting

⚠ Always be sure to wear appropriate PPE: eye & hearing protection.

Cut planks using specified Miter Saw to terminate to accurately measured distances between components and subsequent planks allowing for expansion & contraction. Trim the taped/drilled ends of all stock length material by at least **1/2" (12mm) each end** and discard.

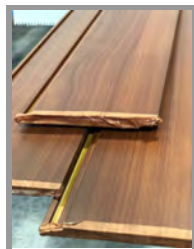

Fastening

Fasteners must be corrosion resistant and comply with all local building codes.

⚠ All fasteners should be suitable for exterior use and be compatible with the substrate type.

Fasteners should be anchored into a solid secure framing member, blocking or furring strip. For vertical applications when the framing member is not available, install diagonal furring strips to securely fasten planks.

Perimeter components should be hard-fastened every **16" (406mm) O.C.** directly through the flange using #8 pan-head screws (supplied by others). These components should be fastened within **8" (203mm)** of the end for secure fastening.

Planks & starter components are secured using Longboard **Quick-Screen Clips** fastened to the substrate every **32" (813mm) O.C.** using #8 pan-head screws (supplied by others). The Quick-Screen Clips are included in the order for 32" (813mm) spacings.

See **Appendix for project specific fastener spacing:**

Quick Screen Clip - Wind Load Tables 3 & 4

Fastener types

RECOMMENDED



CORRECT

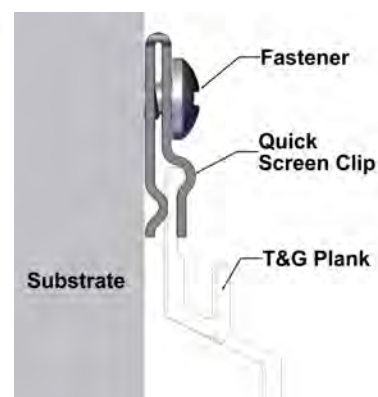

DO NOT USE



INCORRECT

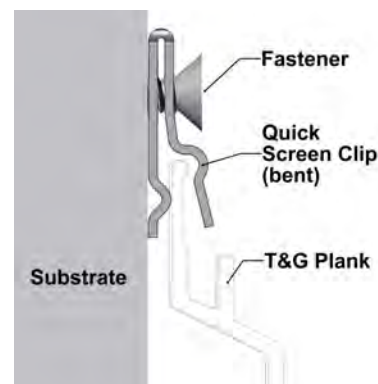

Framing requirements

Always consult the local building authority and follow local building code requirements. The Longboard T&G Cladding system typically weighs approx. 1.5lbs/sq.ft.

Wood Framing

- Size: 2x4 minimum
- Spacing: 16" (406mm) O.C. (see Appendix Table 3 & 4 for reference)
- Sheathing: Exterior grade minimum 7/16" (11mm) plywood/OSB or equivalent exterior wall sheathing.

Metal Framing

- Gauge: 20 ga. minimum (see Appendix Table 3 & 4 for reference)
- Spacing: 16" (406mm) O.C. (see Appendix Table 3 & 4 for reference)
- Sheathing: Exterior grade minimum 7/16" (11mm) plywood/OSB or equivalent exterior wall sheathing.

Concrete/CMU

Wood or metal furring is required over concrete and CMU.

Wood Furring:

- Size: 2x2 minimum
- Type: Pressure treated lumber
- Spacing: 16" (406mm) O.C. oriented vertically

(see Appendix Table 3 & 4 for reference)

Metal Furring:

- Size: 20 ga. minimum (see Appendix Table 3 & 4 for reference)
- Type: Hat channel, c-stud, or z-furring.
- Spacing: 16" (406mm) O.C. oriented vertically
(see Appendix Table 3 & 4 for reference)

System layout

Perimeter and field area limitations

Measure and layout your wall area to consider plank & component alignment with fixtures, penetrations and adjacent walls, for desired appearance (Traditional Components used for illustrative purposes). The same methodology applies for vertical installations.

Seamless runs up to 24' length planks (no butt-joints)

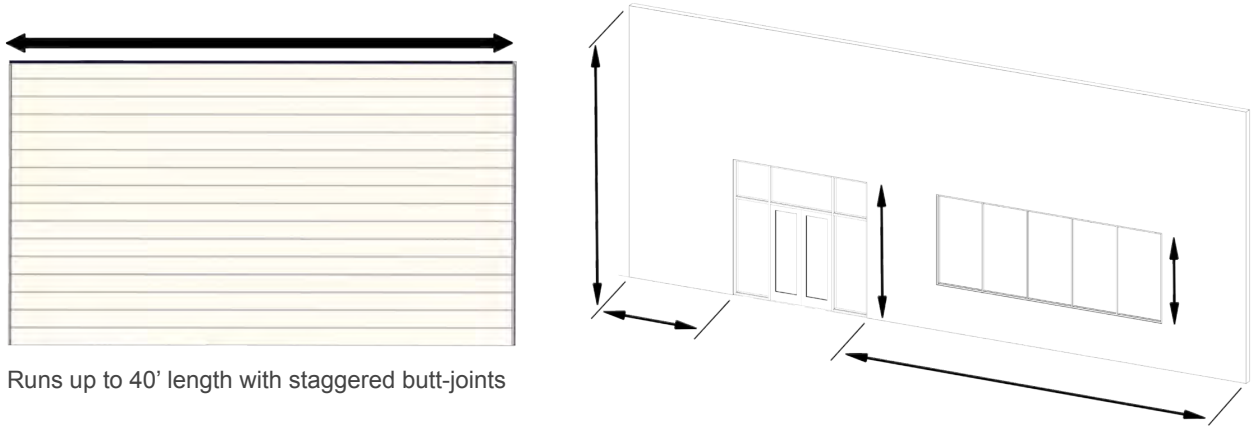

Runs up to 40' length with staggered butt-joints

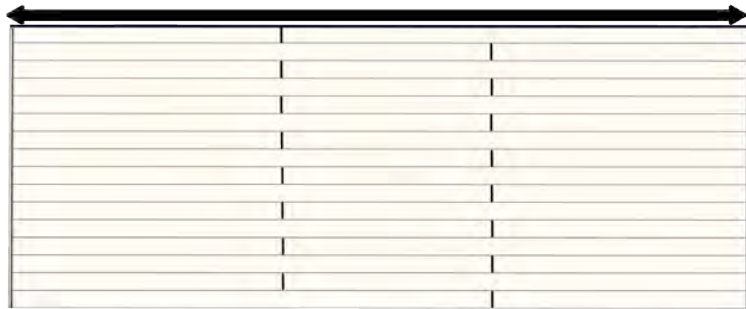

Runs greater than 40' length, use a Reveal set to divide field areas.

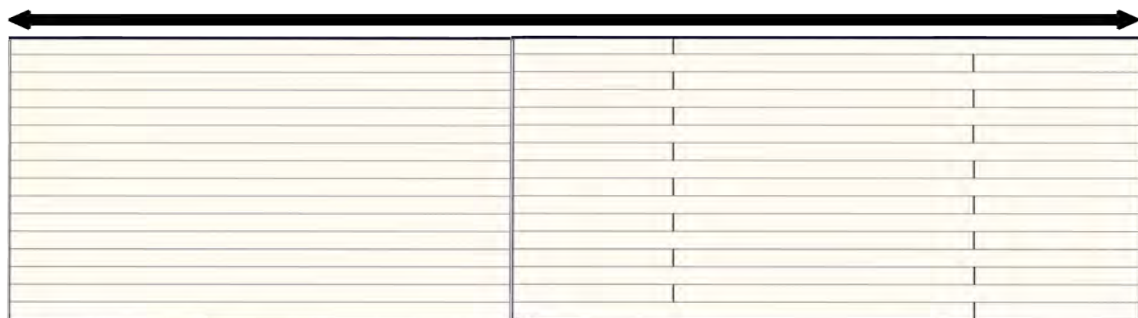

Install perimeter components

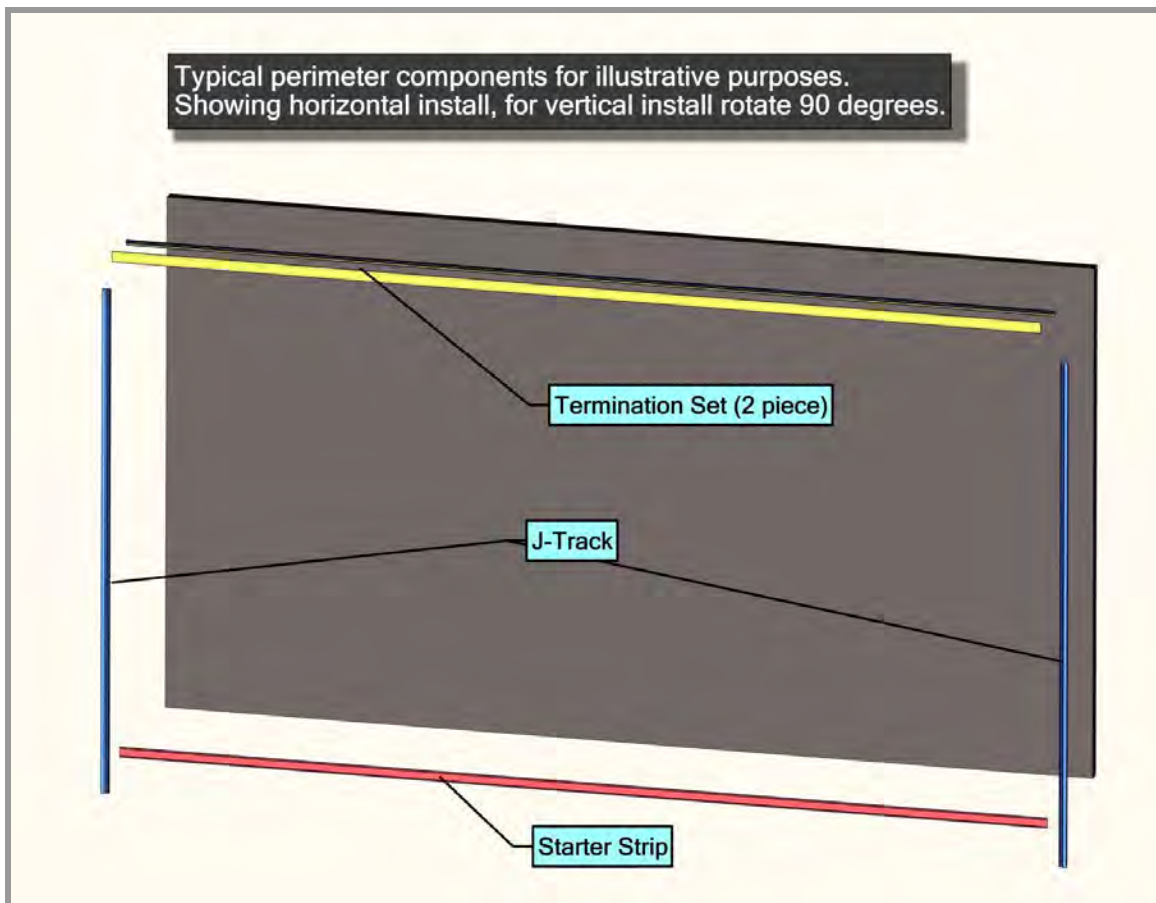

J-Track/Two Piece J-Track

Type: J-Track or Two Piece J-Track
 Location: Perpendicular to Planks (eg: sides of windows and doors), along gable end walls, other angled conditions, window/door headers and other penetrations.
 Details: Notch the flange at the ends where they meet corner components.

Termination Set

Type: Termination Set
 Location: Parallel to Planks along top of wall, underside of windows (horizontal cladding only), sides of windows/doors (vertical cladding only) and other penetrations.
 Details: Install base only to start and end cap once planks are installed.

Starter/Starter J-Track

Type: Starter or Starter J-Track
 Location: Typically along the bottom of the wall(s) for horizontal installs or starting at one side for vertical installs (two starter strips can go back to back in the center of an area to even out planks).
 Details: Can go back to back for vertical installs at the center of each cladding area for equal width ends.

For vertical installs only, install Starter strips back to back then connect the first plank on both sides.

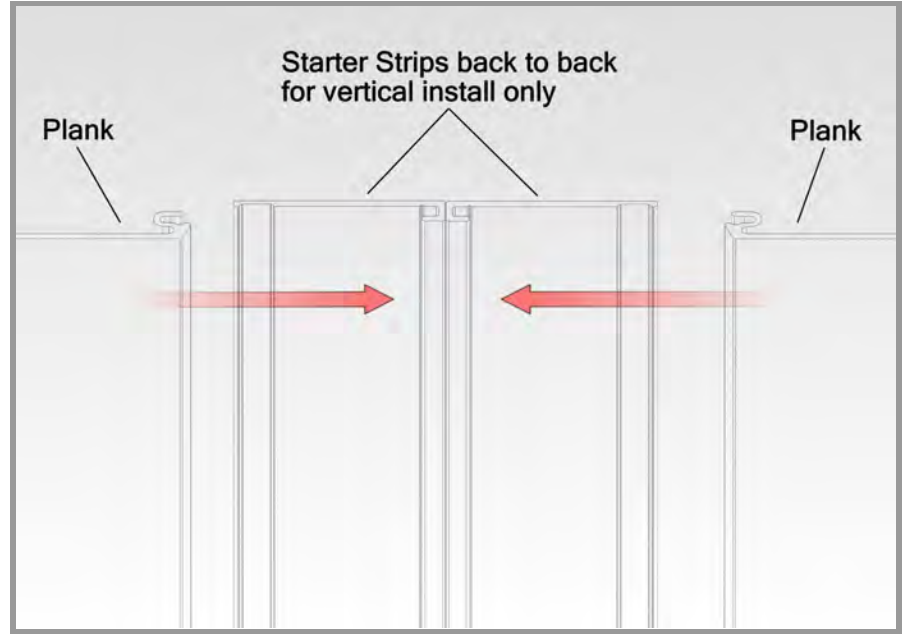

Install vertical back to back Starter strips in the center of wall areas for even layout and symmetry. Continue the planks to the termination end of the install.



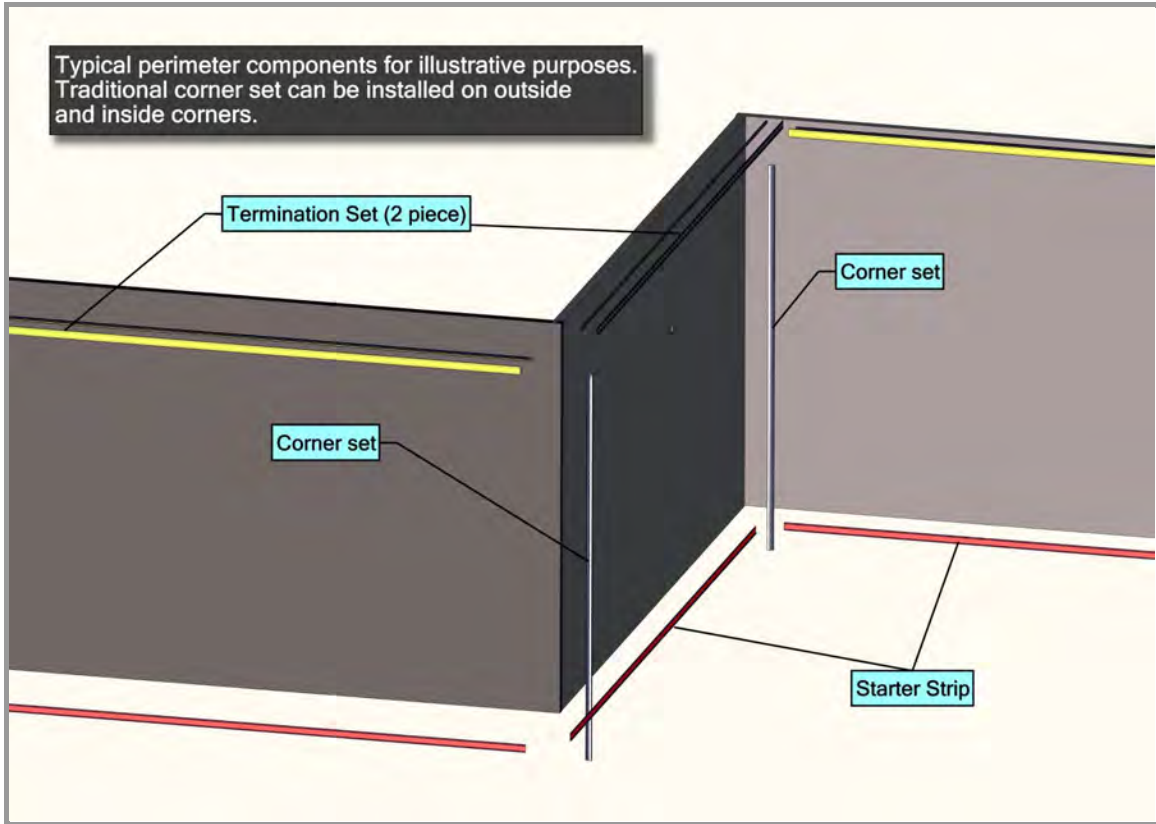

Corners

Type: The Traditional Corner Set (2 piece system).

Location: Inside & outside corners of the area of application.

Details: Typical corner set, also recommended for vertical cladding installs.

Install field components -Floor elevation

Compression Joint

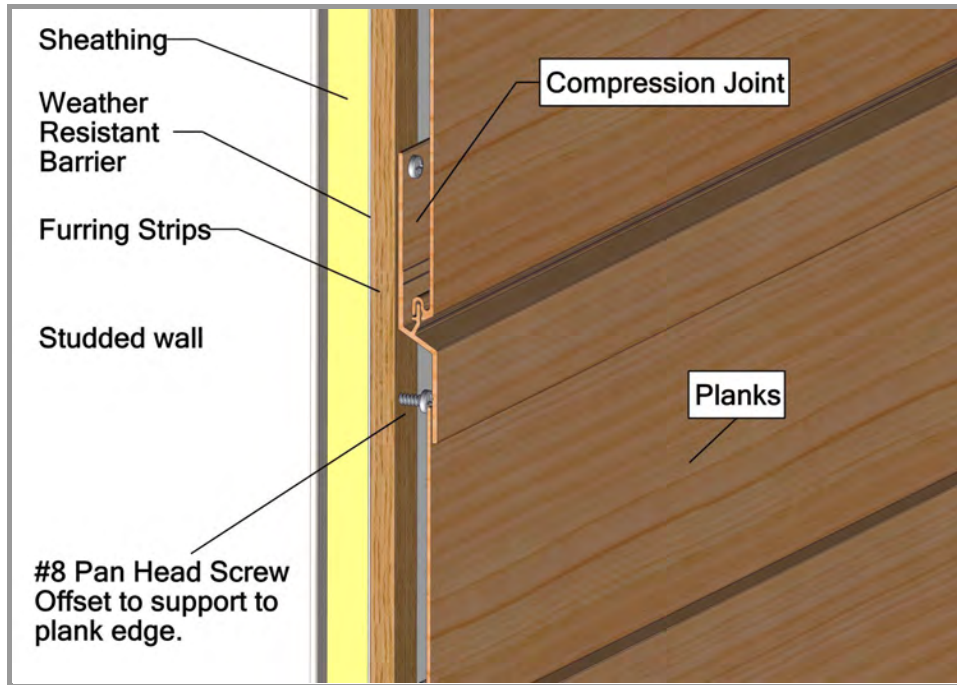

Floor elevation

Type: Compression Joint, Termination set/Starter J-Track, J-Track back to back.
 Location: Typically at every floor elevation and where through-wall flashing is required.
 Details: Note the orientation of planks for through-wall flashing install.

Through-wall Flashing

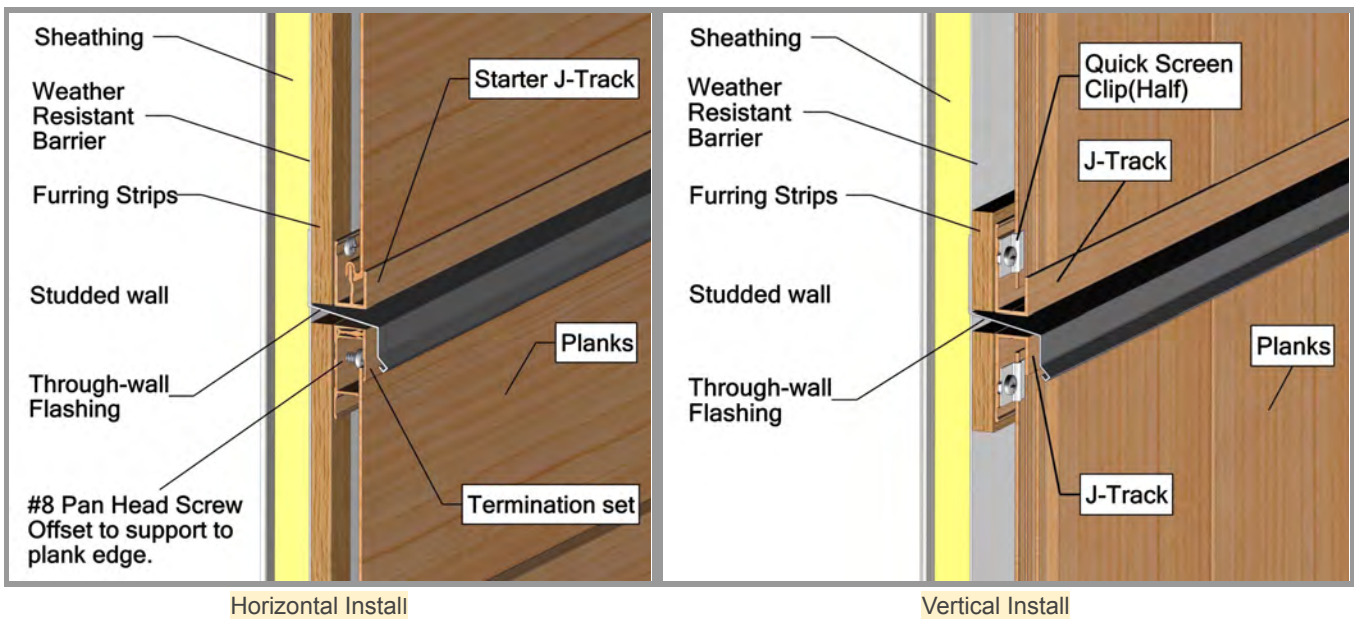

Horizontal Install

Vertical Install

Install field components -Expansion reveal

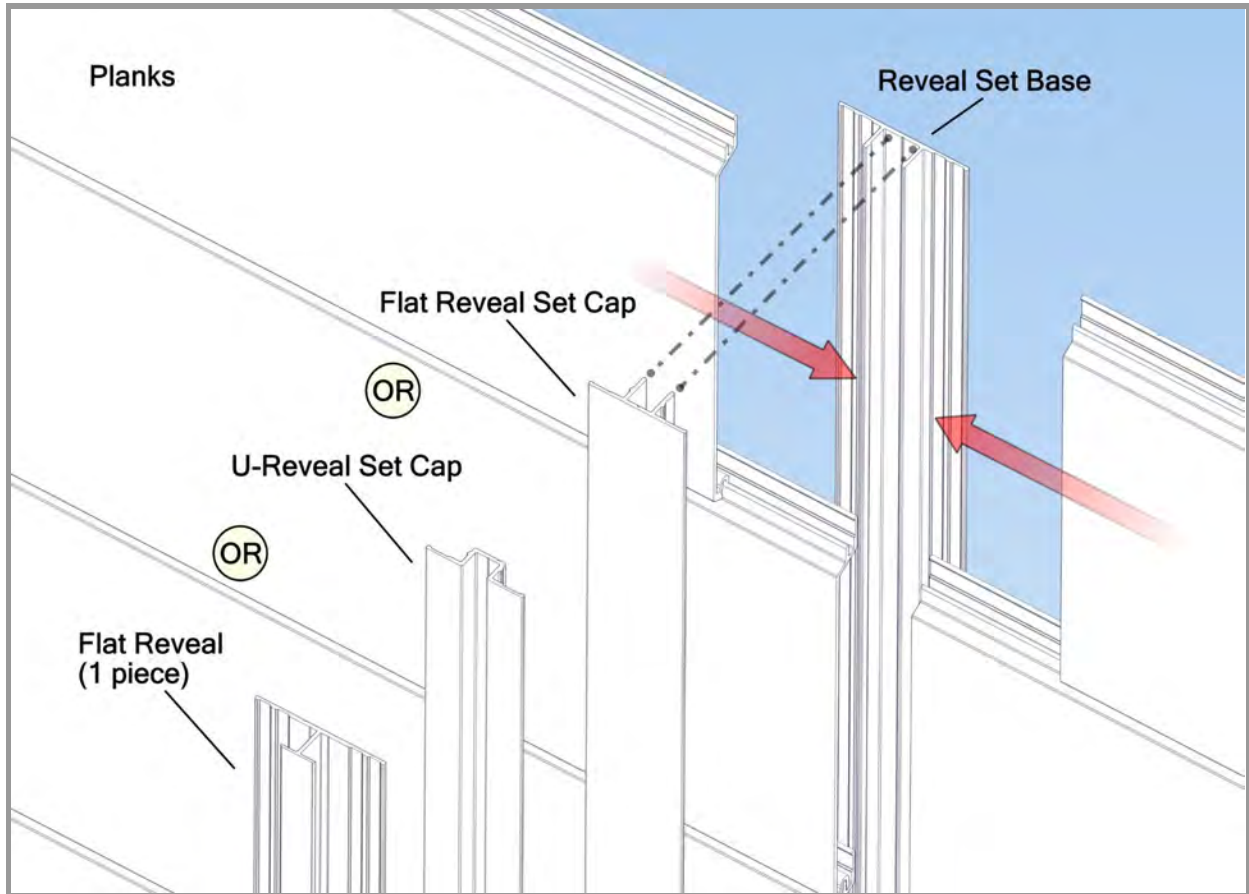

Expansion Reveal (Typical)

- Type: Traditional Flat Reveal Set/Traditional U-Reveal Set/Precision Flat Reveal.
- Location: Typically for wall areas greater than 24' (7.3m) long (no butt-joints) or 40' (12.2m) long (with staggered butt-joints). See **Expansion and contraction** for details.
- Details: Install base only to start and end cap once planks are installed.

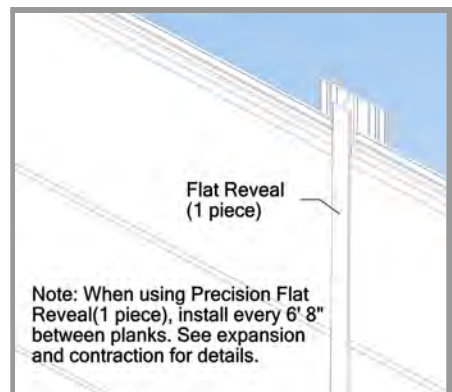
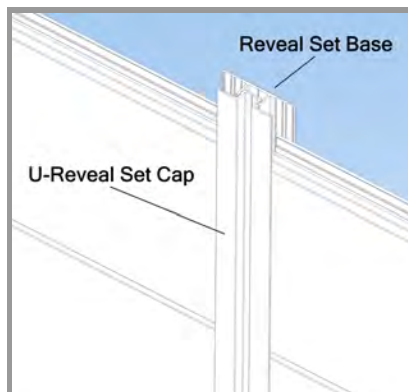
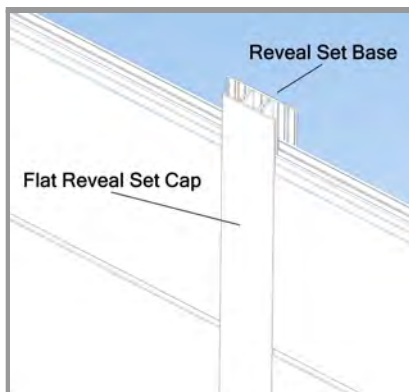

Note: When using Precision Flat Reveal(1 piece), install every 6' 8" between planks. See expansion and contraction for details.

Install plank components

Horizontal

Step 1 -Placement of the plank into the trim.

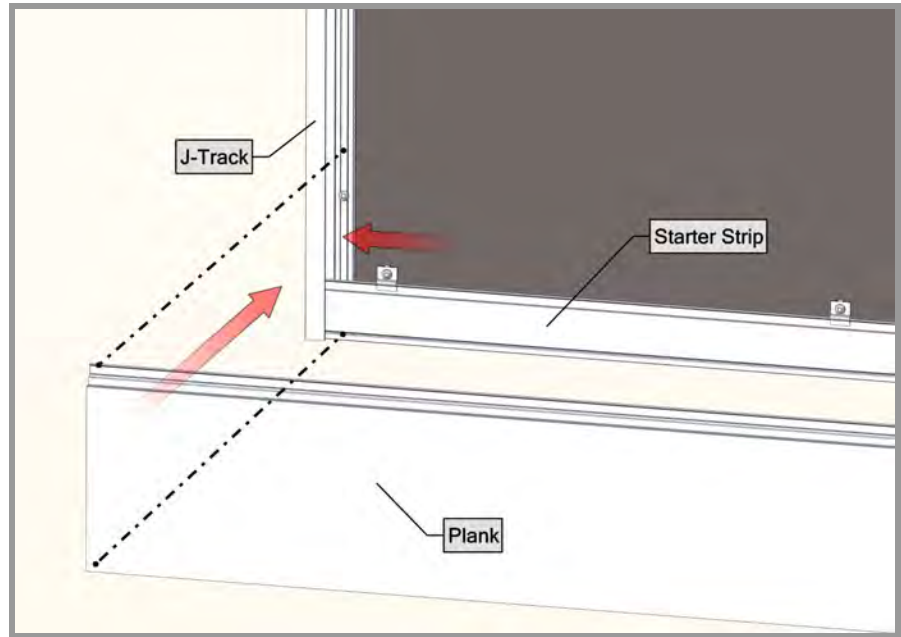

Step 2 -Secure the fit and adjust for the gap (expansion and contraction).

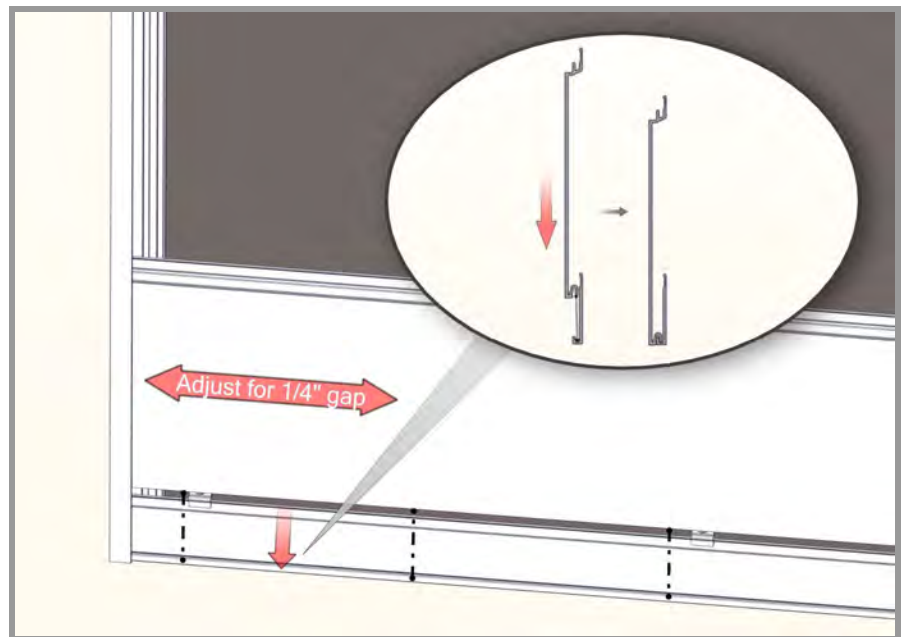

Planks

Type: V-groove, Channel, Smooth plank.

Location: Starting the first row of planks, engaging with the tongue of the Starter or Starter J-Track.

Details: Check for a level installation, shim Quick-Screen Clips where needed to correct any substrate inconsistencies. It is good practice to check your installation every 2-3 rows for level/plumb and flat/straight, for best results.

Step 3 - Install Quick Screen Clips every 32" (813mm) O.C. spacing to secure the top of the planks. Hard fasten only one point at the center of each plank, except where butt-joints are used. See Install techniques for Hard fastening tips.

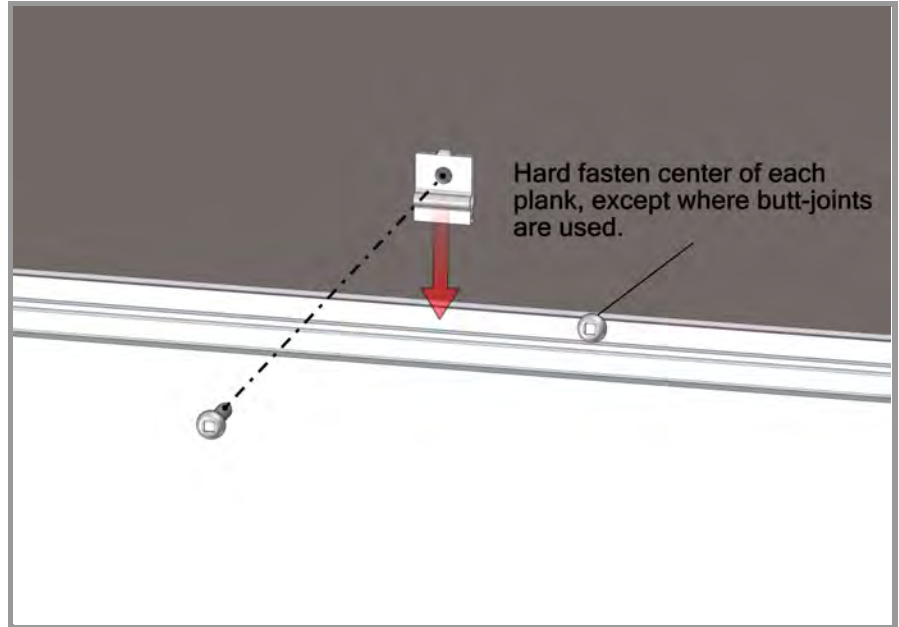

Step 4 - Install planks as needed. Review install techniques for further details and tips.

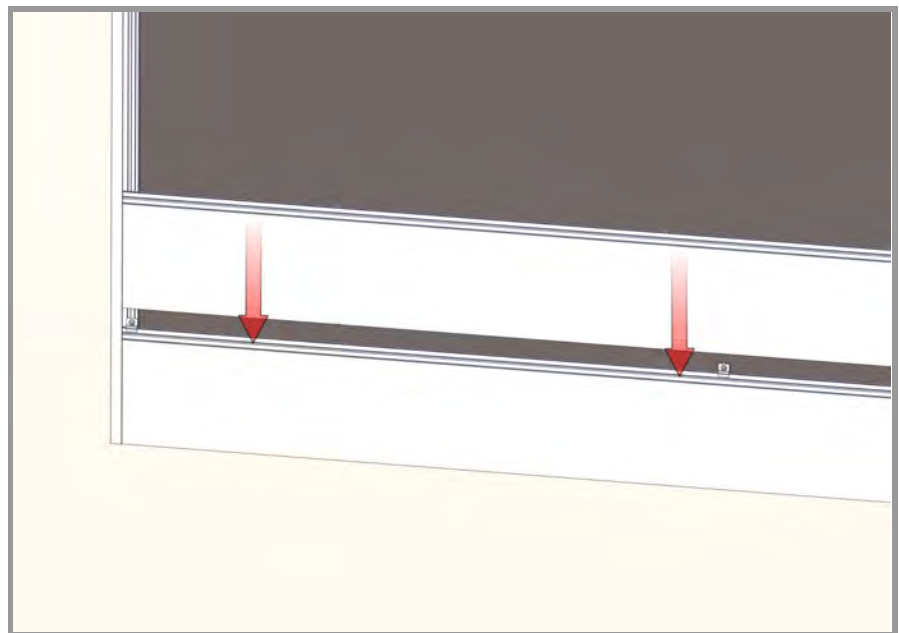

Install plank components

Vertical

Step 1 -Placement of the plank into the trim.

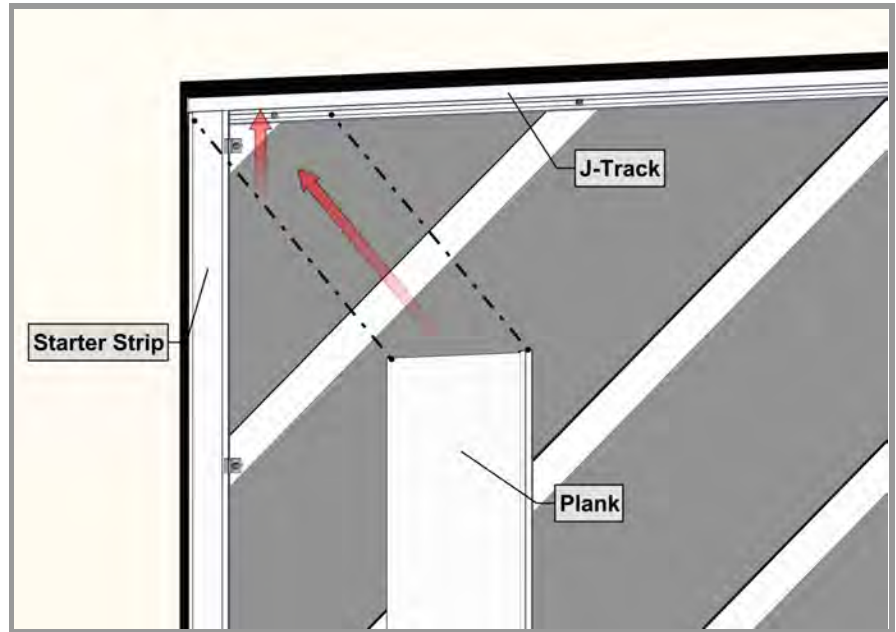

Step 2 -Secure the fit and adjust for the gap (expansion and contraction).

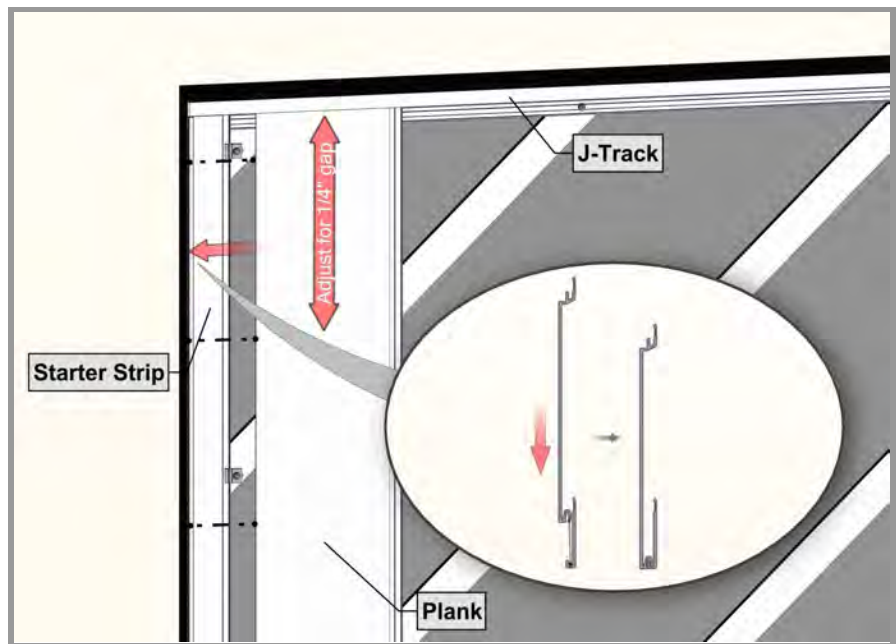

Planks

Type: V-groove, Channel, Smooth plank.

Location: Starting the first row of planks, engaging with the tongue of the Starter or Starter J-Track.

Details: Check for a level installation, shim Quick-Screen Clips where needed to correct any substrate inconsistencies. It is good practice to check your installation every 2-3 rows for level/plumb and flat/straight, for best results.

Step 3 -Install Quick Screen Clips every 32”(813mm) O.C. spacing to secure the top of the planks. Hard fasten only one point at the center of each plank, except where butt-joints are used. See Install techniques for hard fastening tips.

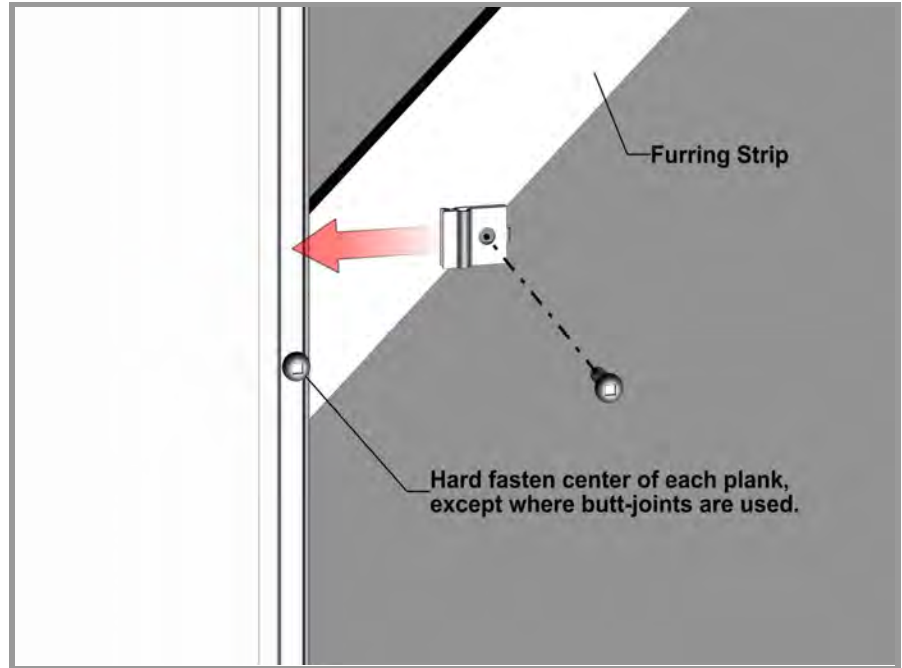

Step 4 -Install planks as needed. Review install techniques for further details and tips.

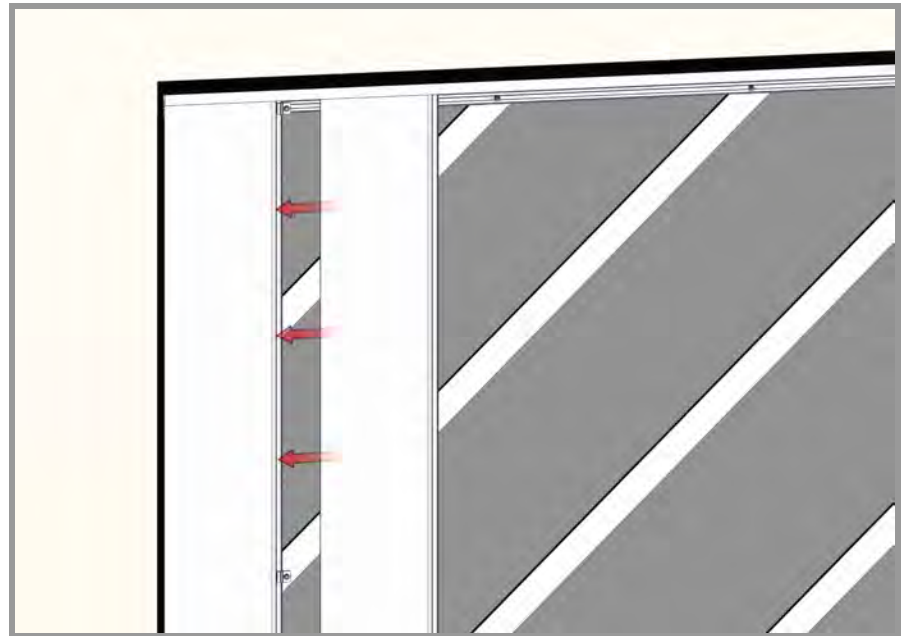

Step 5 - Finishing off edges and angled cuts.

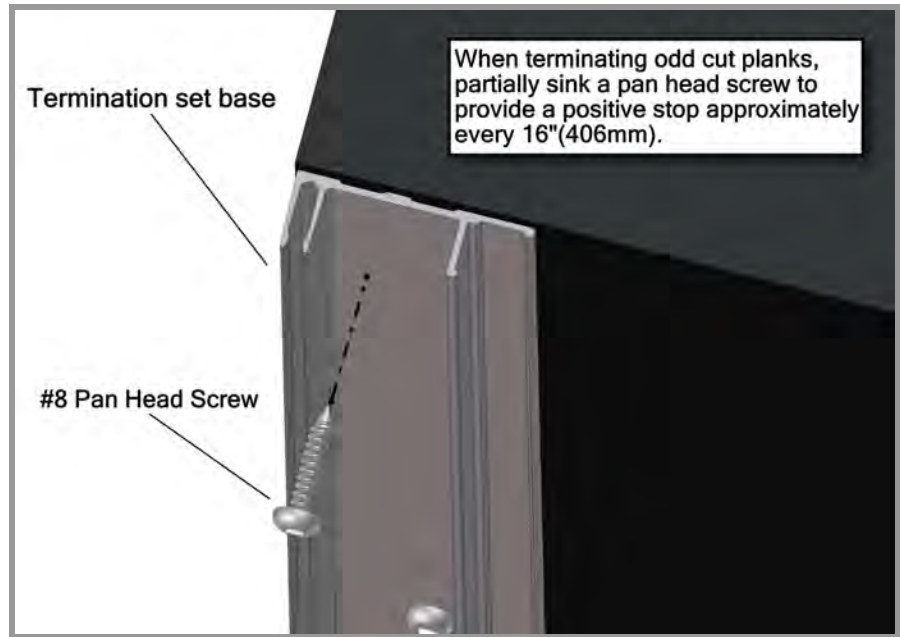

Step 5.1 - Install edge plank with a 1/4" gap and screw to lock the plank into place.

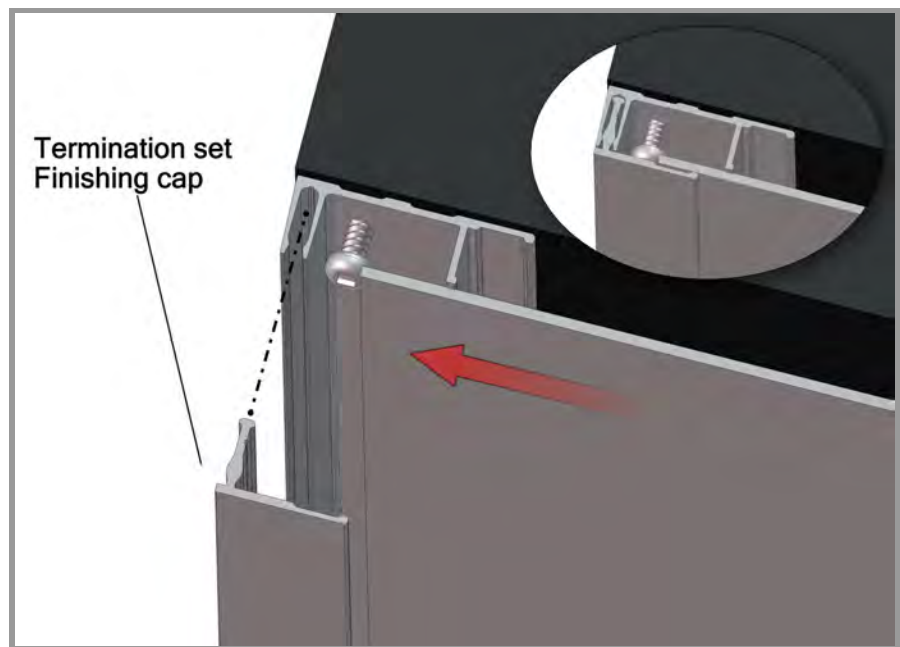

Step 6 -Once planks are installed, finish off the perimeter trims with caps from two piece sets.

Component Caps

Type:	Caps are the finishing piece of the 2 piece component sets.
Location:	Installed onto the base of the 2 piece set.
Details:	If required, use a rubber mallet or hammer and block to protect the finish during this process.

Appendix

Expansion and Contraction Tables

TABLE 1 - IMPERIAL

		AVERAGE TEMPERATURE AT TIME OF CUTTING & INSTALLATION											
°C		-50	-40	-30	-20	-10	0	10	20	30	40	50	
°F		-58	-40	-22	-4	14	32	50	68	86	104	122	
MIN/MAX POST CONSTRUCTION TEMP.	°C	°F	EXPANSION OR CONTRACTION (INCH/FOOT)										
	-50	-58	0.000	-0.003	-0.005	-0.008	-0.011	-0.014	-0.016	-0.019	-0.022	-0.024	-0.027
	-40	-40	0.003	0.000	-0.003	-0.005	-0.008	-0.011	-0.014	-0.016	-0.019	-0.022	-0.024
	-30	-22	0.005	0.003	0.000	-0.003	-0.005	-0.008	-0.011	-0.014	-0.016	-0.019	-0.022
	-20	-4	0.008	0.005	0.003	0.000	-0.003	-0.005	-0.008	-0.011	-0.014	-0.016	-0.019
	-10	14	0.011	0.008	0.005	0.003	0.000	-0.003	-0.005	-0.008	-0.011	-0.014	-0.016
	0	32	0.014	0.011	0.008	0.005	0.003	0.000	-0.003	-0.005	-0.008	-0.011	-0.014
	10	50	0.016	0.014	0.011	0.008	0.005	0.003	0.000	-0.003	-0.005	-0.008	-0.011
	20	68	0.019	0.016	0.014	0.011	0.008	0.005	0.003	0.000	-0.003	-0.005	-0.008
	30	86	0.022	0.019	0.016	0.014	0.011	0.008	0.005	0.003	0.000	-0.003	-0.005
	40	104	0.024	0.022	0.019	0.016	0.014	0.011	0.008	0.005	0.003	0.000	-0.003
50	122	0.027	0.024	0.022	0.019	0.016	0.014	0.011	0.008	0.005	0.003	0.000	

TABLE 2 - METRIC

		AVERAGE TEMPERATURE AT TIME OF CUTTING & INSTALLATION											
°C		-50	-40	-30	-20	-10	0	10	20	30	40	50	
°F		-58	-40	-22	-4	14	32	50	68	86	104	122	
MIN/MAX POST CONSTRUCTION TEMP.	°C	°F	EXPANSION OR CONTRACTION (MM/METER)										
	-50	-58	0.000	-0.230	-0.460	-0.690	-0.920	-1.150	-1.380	-1.610	-1.840	-2.070	-2.300
	-40	-40	0.230	0.000	-0.230	-0.460	-0.690	-0.920	-1.150	-1.380	-1.610	-1.840	-2.070
	-30	-22	0.460	0.230	0.000	-0.230	-0.460	-0.690	-0.920	-1.150	-1.380	-1.610	-1.840
	-20	-4	0.690	0.460	0.230	0.000	-0.230	-0.460	-0.690	-0.920	-1.150	-1.380	-1.610
	-10	14	0.920	0.690	0.460	0.230	0.000	-0.230	-0.460	-0.690	-0.920	-1.150	-1.380
	0	32	1.150	0.920	0.690	0.460	0.230	0.000	-0.230	-0.460	-0.690	-0.920	-1.150
	10	50	1.380	1.150	0.920	0.690	0.460	0.230	0.000	-0.230	-0.460	-0.690	-0.920
	20	68	1.610	1.380	1.150	0.920	0.690	0.460	0.230	0.000	-0.230	-0.460	-0.690
	30	86	1.840	1.610	1.380	1.150	0.920	0.690	0.460	0.230	0.000	-0.230	-0.460
	40	104	2.070	1.840	1.610	1.380	1.150	0.920	0.690	0.460	0.230	0.000	-0.230
50	122	2.300	2.070	1.840	1.610	1.380	1.150	0.920	0.690	0.460	0.230	0.000	

TABLE 3

4" PLANKS		PSF (Factored / Ultimate)											
		20	30	40	50	60	70	80	90	100	110	121	
QUICK-SCREEN CLIP SPACING (IN) ^{1, 2, 3}	16"	Wood											
		16ga											
		18ga											
		20ga											
	24"	Wood											
		16ga											
		18ga											
		20ga											
	32"	Wood											
		16ga											
		18ga											
		20ga											

Substrate Types: Sheathed Wood-Frame Wall w/2.0 in. lg. #8 Pan-head wood screws
 Sheathed 16ga, 50ksi Steel Stud Wall w/#8 Pan-Head Self-Drilling Screws
 Sheathed 18ga, 33ksi Steel Stud Wall w/#8 Pan-Head Self-Drilling Screws
 Sheathed 20ga, 33ksi Steel Stud Wall w/#8 Pan-Head Self-Drilling Screws

1_Spacing is from clip center to center
 2_An unfactored dead load of 1.5 psf was assumed for the cladding
 3_If fastening to every second stud, the attachment stud shall be staggered between adjacent runs of cladding

TABLE 4

6" PLANKS		PSF (Factored / Ultimate)											
		20	30	40	50	60	70	80	90	100	110	121	
QUICK-SCREEN CLIP SPACING (IN) ^{1, 2, 3}	16"	Wood											
		16ga											
		18ga											
		20ga											
	24"	Wood											
		16ga											
		18ga											
		20ga											
	32"	Wood											
		16ga											
		18ga											
		20ga											

Substrate Types: Sheathed Wood-Frame Wall w/2.0 in. lg. #8 Pan-head wood screws
 Sheathed 16ga, 50ksi Steel Stud Wall w/#8 Pan-Head Self-Drilling Screws
 Sheathed 18ga, 33ksi Steel Stud Wall w/#8 Pan-Head Self-Drilling Screws
 Sheathed 20ga, 33ksi Steel Stud Wall w/#8 Pan-Head Self-Drilling Screws

1_Spacing is from clip center to center
 2_An unfactored dead load of 1.5 psf was assumed for the cladding
 3_If fastening to every second stud, the attachment stud shall be staggered between adjacent runs of cladding

Proper Handling of Longboard Products



To help avoid injury and product damage, Longboard products require proper handling to and from storage areas during installation. When carrying or installing any products it is recommended that they be moved or carried by at least two people with each support point approximately 4ft from the ends. **Carrying products without proper support can cause excessive bending which may damage the appearance or finish of the product.** Any short cut lengths should also be carried on edge while supporting the material. See below for details.

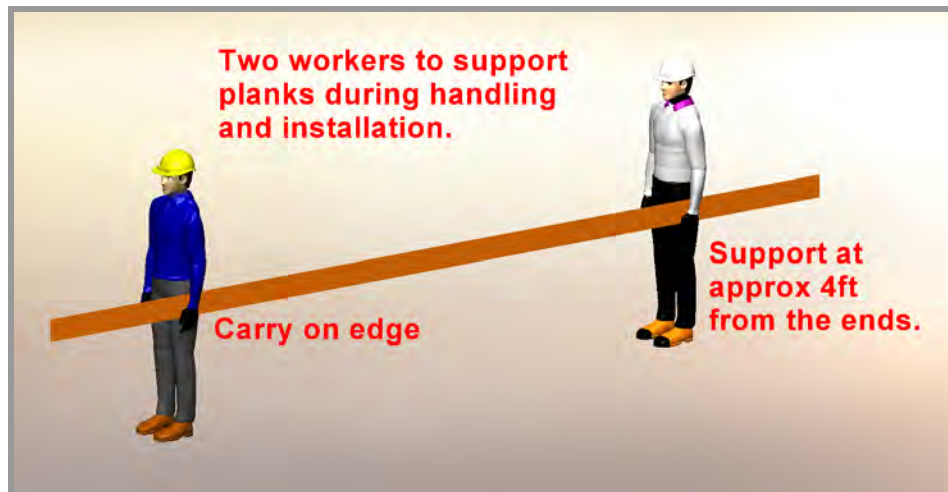

⚠️ Delivery, Storage & Handling ⚠️

- Always inspect the delivery for damage and contact LB ASAP if there are any issues: info@longboardproducts.com or 1-800-604-0343 and include your PO# and any pictures if possible. Longboard is not responsible for the installation of blemished or damaged material.
- Be sure to store the material flat, keep it dry, safe & secure and remain in unopened cartons until ready to be installed.
- Always wear appropriate PPE when handling products.



BLANK PAGE



Longboard Architectural Products Inc.
© Longboard Architectural Products Inc. All rights reserved.

Longboard® is a registered trademark of Longboard Architectural Products Inc.

Longboard
1777 Clearbrook Road
Abbotsford, BC V2T 8X8
Canada
longboardproducts.com

Every effort has been made to ensure that the information in these installation guidelines are accurate. Longboard is not responsible for printing or clerical errors.

For more information, contact client care at info@longboardproducts.com or call toll free 1-800-604-0343.

Endura Tongue & Groove Planks

V-Groove Planks

Size	12' *	24' †	12' Perf *	24' Perf †
2½"	3V.145	3V.289	3VP.145	3VP.289
4"	4V.145	4V.289	-	-
6"	6V.145	6V.289	6VP.145	6VP.289

Smooth Planks

Size	12' *	24' †	12' Perf *	24' Perf †
6"	6PSP.145	6PSP.289	6PSP.145	6PSP.289

Channel Planks

Size	12' *	24' †
6"	6CH.145	6CH.289

Accessories

Product	Qty	SKU
Quick Screen Clips	1750, box	CLIP.N1750
Quick Screen Clips	100, bag	CLIP.N100
Touch Up Pens <i>Reach out to confirm color with account manager</i>	N/A	TUP

Acoustical Soundtex® Scrim

Size	12' *	24' †
6" V-Groove Plank	6PSP.145	6PSP.289
6" Smooth Plank	6SPPA.145	6SPPA.289

Component Trims

Type	Style	Product	Dimensions	SKU
Starter	Precision	Starter J-Track	(5/8") - 12'	1SJT.145
Starter	Traditional	Starter Strip	(1-7/8") - 12'	2SS.145
Starter	Traditional	Back-to-Back Starter Strip	(1-1/4") - 12'	2BTBSS.145
J-Track	Precision	Two Piece J-Track	(5/8") - 12'	1X1JT.145
J-Track	Precision	J-Track	(5/8") - 12'	1JT.145
J-Track	Craftsman	Two Piece J-Track	(7/8") - 12'	JT23S.145
J-Track	Traditional	Two Piece J-Track	(1-3/8") - 12'	1X2JT.145
Corner	Precision	Outside Corner	(3/16") - 12'	05OC.145
Corner	Craftsman	Inside Corner	(3/4") - 12'	1IC.145
Corner	Craftsman	Outside Corner	(1") - 12'	1OC.145
Corner	Traditional	Corner Set	(2") - 12'	2CORS.145
Reveal	Precision	Flat Reveal	(1/2") - 12'	1FR.145
Reveal	Precision	T&G Flat Reveal	(1/2") - 12'	1TGFR.145
Reveal	Craftsman	U-Reveal Set	(3/4") - 12'	1URS.145
Reveal	Craftsman	T&G U-Reveal	(3/4) - 12'	1TGURK.145
Reveal	Traditional	U-Reveal Set	(1-1/2") - 12'	2URS.145
Reveal	Traditional	Flat Reveal Set	(1-1/2") - 12'	2FRS.145
Reveal	Traditional	T&G U-Reveal	(1 1/2") - 12'	2TGURK.145
Reveal	Traditional	Offset Flat Reveal Set, J-Track Base	(2") - 12'	2OFFJ.145
Reveal	Traditional	Offset Flat Reveal Set, Termination Base	(2") - 12'	2OFFT.145
Termination	Precision	Termination Set	(5/8") - 12'	1TS.145
Termination	Craftsman	Termination Set	(7/8") - 12'	TS.145
Termination	Traditional	Termination Set	(1-3/8") - 12'	2TS.145
Compression Joints	Traditional	Compression Joint	(1-3/8") - 12'	2CJ.145

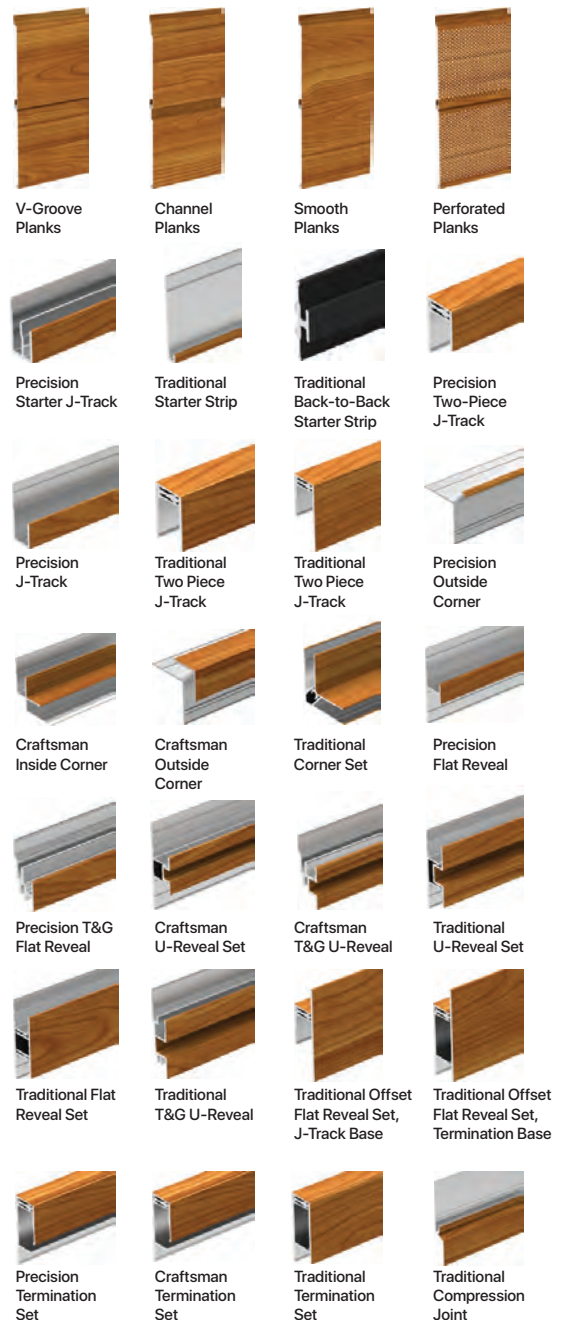

* 48 sq. ft. box quantities † 96 sq. ft. box quantities

Intrepid Link & Lock™ Battens

Size	12'	24'	End Caps (20/box)	End Mounts (20/box)	Mounting Accessories	Qty	SKU
2"	2X2LL.145	2X2LL.289	2LLEC.2	2LLEM.2	Link & Lock Mounting Clip	48, bag	LLMC.N48
4"	2X4LL.145	2X4LL.289	2LLEC.4	2LLEM.4	Dewalt® 1/2" Pilot Point Drill Bit	1	DRILLBT.05
6"	2X6LL.145	2X6LL.289	2LLEC.6	2LLEM.6	24' Link & Lock Internal Stiffener	1	LLSTIFF.289
8"	2X8LL.145	2X8LL.289	2LLEC.8	2LLEM.8	3M® Double Sided Adhesive Tape - 108'	1, roll	LLTAPE.1296



Link & Lock™ Batten

Privacy Screen System

Size	Product	24'	End Caps (20/box)	Mounting Accessories	Qty	SKU
1x3"	Privacy Beam	1X3B.289	1BEC.3	1x3" & 1x5" Spacer Block	100, box	2X2SB.N100
1x5"	Privacy Beam	1X5B.289	1BEC.5	1x3" & 1x5" Spacer Bar	1	1X2FB.145
2x2"	Privacy Post	2X2SP.289	2X2PC.2	1x3" Spacer Bar	100, box	1X2FB.1
1x3"	Privacy Post	2X3DP.289	2X3PC.3	1x5" Spacer Bar	100, box	1X2FB.3
				3" Mounting Bracket	100, box	3PSMB.1
				#10 Black Screws	100, box	PECS.N100



Privacy Beam

Dauntless System

Dimensions	Product	24'	End Caps (20/box)
1-5/8" x 4"	Beam	2X4CB.289	2BEC.4
1-5/8" x 6"	Beam	2X6CB.289	2BEC.6

Hanger Bracket Mounting System

Product	Kind	Qty	SKU
Side Rail	24' Carrier Rail	1	2CBSR.289
Beam Spine Connection Top	Accessory	1	BSCT.6
2" Hanger Bracket	Bracket	1	CBHB.2
4" Hanger Bracket	Bracket	1	CBHB.4
6" Hanger Bracket	Bracket	1	CBHB.6
8" Hanger Bracket	Bracket	1	CBHB.8
10" Hanger Bracket	Bracket	1	CBHB.10
12" Hanger Bracket	Bracket	1	CBHB.12

Clip Mounting System

Product	Kind	Qty	SKU
Single Rail ^A	24' Carrier Rail	1	CBR.289
Double Rail ^A	24' Carrier Rail	1	CBDR.289
1-1/2" Single Hanger Clip	Clip	20, box	HCS.2
3" Hanger Clip	Clip	20, box	HC.3
Eye Bolt with T-Nuts	Attachment	20, box	CBEB.N20

^AIncludes 7 Eye-Bolts with T-Nuts



Clip Assembly



Hanger Bracket Assembly

Finishes

Woodgrain	15 Year Warranty	Woodgrain	15 Year Warranty	Solid Color	15 Year Warranty	Specialty	15 Year Warranty
Birchwood	15BWD	Light Bamboo	15LBB	Black	15BLA	Anodic Ice	15AIC
Beechwood	15BEE	Light Cherry	15LCY	Bone White	15BWH	Biscotti	15BIS
Blonde Oak	15BOK	Light Fir	15LFR	Brick Red	15BRD	Burnt Sienna	15BSN
Dark Acacia	15DAC	Light National Walnut	15LNW	Charcoal	15CHA	Canyon Vista	15CVI
Dark Antique Oak	15DOA	Light Oak	15LOK	Chili Pepper	15CHP	Ceramic Clay	15CCL
Dark Bamboo	15DBB	National Mahogany	15NMH	Classic Bronze	15CBZ	Copper Penny	15CPE
Dark Cherry	15DCY	Sand Drift	15SDR	Dark Brown	15DBR	Moonstone	15MOO
Dark Fir	15DFR	Southern Yellow Pine	15SYP	Graphite	15GRA	Old Navy	15ONA
Dark Knotty Pine	15DKP	Table Walnut	15TWL	Medium Blue	15MBL	Platinum Ice	15PIC
Dark National Walnut	15DNW	Weathered Grey	15WGY	Slate Grey	15SGR	Venus	15VEN
Dark Walnut	15DWL	Western Cedar	15WCD	Ultra White	15UWH		
Italian Rosewood	15IRW	White Oak	15WOK				
Naturally Aged Metals	15 Year Warranty						
Carbon Mist	15CMI						
Molten	15MOL						
Smokey Topaz	15STO						
Toasted Mocha	15TMO						

Example of complete product SKU

6V.289.15DFR
(Product.Length.Finish)

Finish Options

We help you achieve your vision. Whether you're looking to create a space that offers the warmth of natural woodgrain or a modern industrialized aged metal, we have a finish option for you.

Require a custom finish or color? Our experienced color matching team can make it a reality.

Special order finishes may require additional production lead time or pricing.

- Interior Only
- Special Order
- High Gloss Finish
- Shimmer Finish
- Low Gloss Finish
- Terracotta Finish

Woodgrains

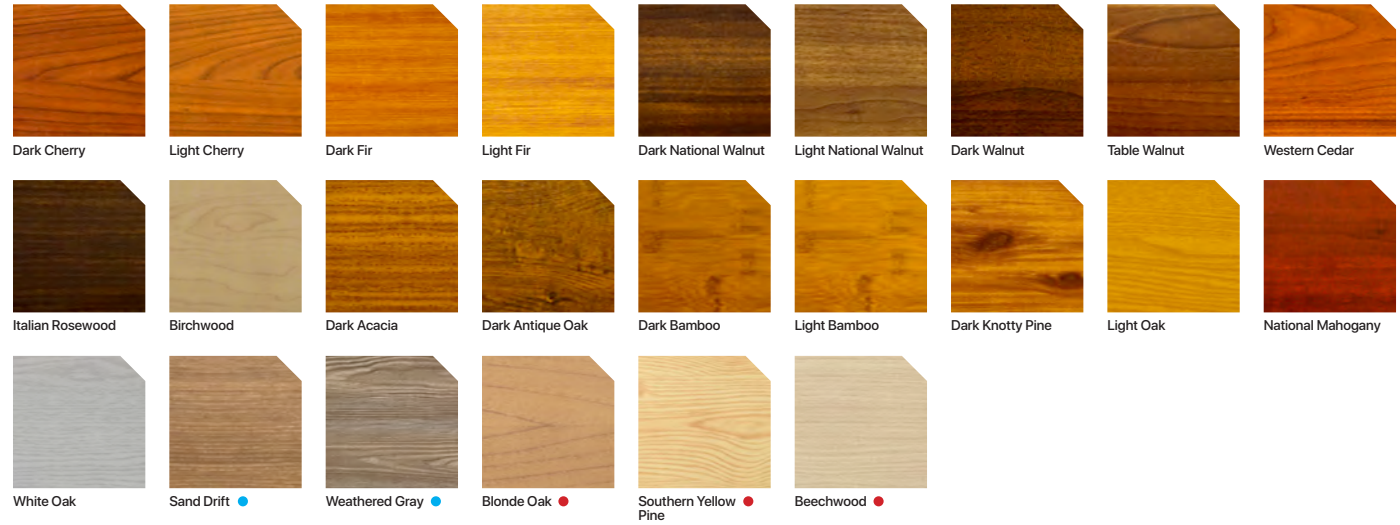

Solid Colors

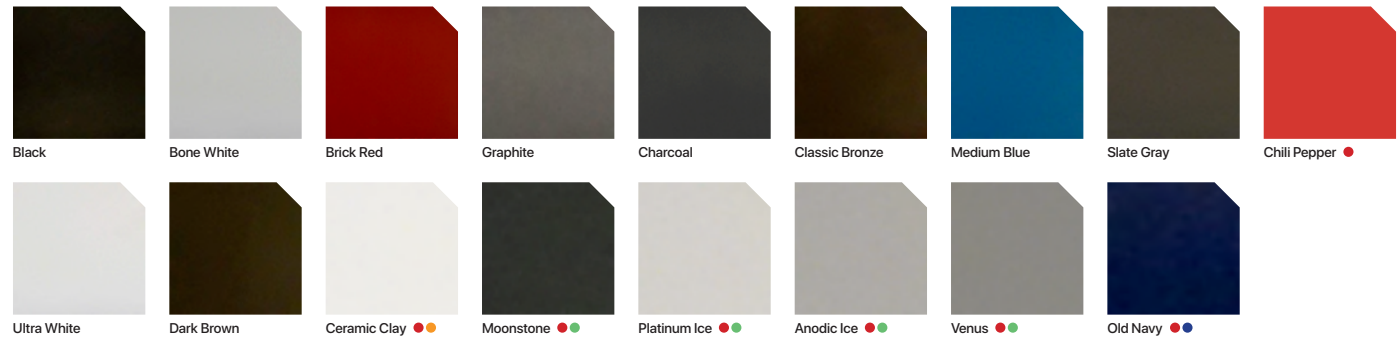

Naturally Aged Metals



Others

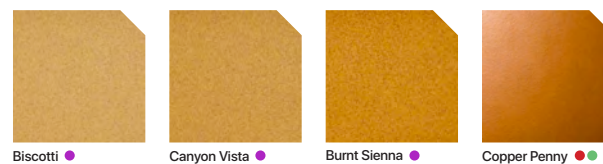

Warranty granted to (company name):

Product codes: Product description:

Contractor/owner

Project name

Project address

Longboard Architectural Products Inc. ("Longboard," "The Company") products as identified by the Product Codes listed will conform to the standards set out in Clause 1 and Clause 2 of this Warranty, subject to the terms and conditions set out in Clause 3 and 4 of this Warranty.

Address 2

Date of completion

Finish:

Product on jobsite

Clause 1

Extruded Aluminum Profile(s)

Longboard expressly warrants that its product line is free from manufacturing defects in material or workmanship.

- 1.1 When siding is applied according to Longboard instructions and properly maintained, such product is guaranteed against the following:
- 1.2 Buckling: The product itself will be free of any buckling that is not associated with the substrate and/or structure to which the Longboard system is attached. For the purpose of this warranty, buckling shall be defined as warping of the product(s) exceeding one sixteenth of an inch out of plane per linear foot.
- 1.3 Corrosion: When applied according to Longboard instructions and properly maintained, such product is further guaranteed against rusting and corroding. Subject to the limitations set out in Clause 3 and 4.
- 1.4 What we will do: If, during the fifteenth (15th) year Limited Warranty Period on the powder coating finish, the Product is defective in material or workmanship, Longboard will, in its sole discretion, either repair or replace the defective portion of the Product.
- 1.5 What we will do: If, during the 50-year Limited Warranty Period on the aluminum extruded profiles, the Product is defective in material or workmanship, Longboard will, in its sole discretion, either repair or replace the defective portion of the Product.
- 1.6 After the 15th year, this Limited Warranty on the powder coated finish will expire and shall no longer be applicable.
- 1.7 After the 50th year, this Limited Warranty on the aluminum extruded profile(s) will expire and shall no longer be applicable.
- 1.8 Longboard replacement of the defective Product or reimbursement of this Limited Warranty is the exclusive remedy for the Covered Person for any defect in materials or workmanship. The Company will not refund or pay any costs in connection with labor or accessory materials.

Clause 2

- 2.1 During the first fifteen (15) years of this warranty:
- 2.2 Checking/Cracking: No visible checking or cracking of the product finish on the building.
- 2.3 Chalking Resistance: No chalking of the product finish on the building in excess of that represented by No.6 rating based on ASTM D4214.
- 2.4 Color Retention: No color change of the product finish on the building greater than 5 (five) CIE Lab ΔE units calculated in accordance with ASTM 2244 Section 6.3. Color change shall be measured on the exposed paint surface which has been cleaned of oil, grease, chalk, oxidized film or other contaminants, corresponding values shall be measured on the control panel.
- 2.5 Gloss Retention: Coated surface will exhibit gloss retention

of a minimum of 30% of the original. Gloss retention shall be measured on the exposed paint surface which has been cleaned of oil, grease, chalk, oxidized film or other contaminants, corresponding values shall be measured on the control panel.

- 2.6 Adhesion: Adhesion of product finish when initially applied to test panels and measured by reference to AAMA 2604-02 Clause 7.4.2 will show no removal of the film.

Clause 3

- 3.1 Warranty Terms and Conditions:
- 3.2 The "Warranty Period" for the warranties in Clause 1 shall mean fifty (50) years or for as long as the original "owner" and/or "purchaser" named above shall live and own the property on which the material was originally installed.
- 3.3 Clause 3: Shall mean fifteen (15) years, commencing on the date of completion.
- 3.4 Registration of the product is required for the warranty to be in effect. This warranty is valid for the original purchaser and one other owner of the structure where the product(s) have been installed.
- 3.7 Normal atmospheric conditions exclude corrosive or aggressive atmospheres such as those contaminated with chemical fumes or other corrosive elements. The product finish is not meant for marine use on boats, ships or offshore platforms.

Clause 4

- 4.1 This warranty will not extend or cover:
- 4.2 Damages to the coated metal caused by handling, shipping, processing and/or installation; or
- 4.3 Damages to the coated metal caused by scratching or abrading after installation; or
- 4.4 Damages to the coated metal as a result of standing water in horizontal installations.
- 4.5 The warranty will not be applicable to damage or failure, which is caused by acts of God, falling objects, external forces, explosions, fire, riots, civil commotion's, acts of war, or other such similar or dissimilar occurrences beyond The Company's control.
- 4.6 Customer shall make available to The Company the dates of the installation of the coated metal, the maintenance records including details of washing and cleaning procedures in compliance with the annual cleaning requirements as stated in the Required Maintenance section of this warranty. Customers shall demonstrate that the failure of the coated metal was due to a breach of the warranty stated herein.
- 4.7 Claims must be made in writing to Longboard within 30 days of the discovery of a problem and authorization obtained prior to beginning any repair and/or refinishing work. The claimant must provide proof of coverage. Claims can be made by writing to Longboard at the Product Performance Department. After receiving such notice, The Company

must be given a reasonable opportunity to inspect and verify the claim.

- 4.8 Longboard exclusive liability under this warranty, or otherwise, will be limited to refinishing and/or repairing, at The Company's sole discretion, the defective powder coating. The warranty on any refinished, repaired or replaced coated metal supplied hereunder shall be for the remainder of the warranty period applicable to the originally coated metal. All warranty work will be performed by a company or contractor selected by Longboard. Color variance between refinished and/or repainted product and original shall not be indicative of a defect.
- 4.9 This warranty represents the entire agreement between parties in relation to its subject matter and supersedes any previous agreement whether written or oral between the parties in relation to its subject matter. The limited warranties state the entire liability of Longboard with respect to the products covered by them. The Company shall have no liability for any incidental or consequential damages. No person is authorized to make any representation or warranty on behalf of Longboard except as expressly set forth above, and any such statement shall not be binding on The Company. Except as expressly set forth above, Longboard makes no warranty of any kind, express or implied, including, without limitation, any implied warranty of merchantability or fitness for a particular purpose. Warranties shall be the duration of the limited warranty, or such shorter duration as provided under applicable local law. These limited warranties give you specific legal rights, and you may also have other rights which vary from area to area.
- 4.91 Nothing in this warranty shall be construed as a warranty of the workmanship of any installer or as imposing on Longboard any liability for unsatisfactory performance caused by faulty workmanship in installation.
- 4.92 It's agreed all parties involved that all claims and disputes relating to this agreement that cannot be settled through negotiation will try in good faith to first settle the dispute by mediation administered by the American Arbitration Association (Construction Industry Mediation Procedures) as a prelude to mandatory binding arbitration. Such binding arbitration is to be conducted and administered by the Construction Industry Arbitration Rules of the American Arbitration Association. Both seller and purchaser agree to share equally in the costs of both mediation and arbitration and that such binding arbitration will be the sole and final remedial action.
- 4.93 Required Maintenance. On an annual basis use a soft sponge or cloth, water and mild detergent, non-abrasive soap with the pH range of 5-9 to clean the powder coated area of dirt, grime and other debris. Pressure washing and the use of harsh detergents or chemicals is not recommended. Include in your maintenance records the following: date, time, specific products used, name of maintenance person and their designation, maintenance company name and general condition of the powder coated finish.

I have read and agree to the terms of the Longboard® Product 15 year powder coated surface and 50 year aluminum extruded profile(s) warranty and acknowledge receipt of a copy of the Warranty Certificate.

Name of owner or contractor:

Date:

Signature:



Duly authorized on behalf of Longboard:

Name and designation:

Date:

Signature:

Warranty granted to (company name):

Product codes: Product description:

Contractor/owner

Project name

Project address

Address 2 Date of completion

Product on jobsite

Longboard Architectural Products Inc. ("Longboard," "The Company") products as identified by the Product Codes listed will conform to the standards set out in Clause 1 and Clause 2 of this Warranty, subject to the terms and conditions set out in Clause 3 and 4 of this Warranty.

Finish:

Clause 1

Extruded Aluminum Profile(s)

Longboard expressly warrants that its product line is free from manufacturing defects in material or workmanship.

- 1.1 When siding is applied according to Longboard instructions and properly maintained, such product is guaranteed against the following:
- 1.2 Buckling: The product itself will be free of any buckling that is not associated with the substrate and/or structure to which the Longboard system is attached. For the purpose of this warranty, buckling shall be defined as warping of the product(s) exceeding one sixteenth of an inch out of plane per linear foot.
- 1.3 Corrosion: When applied according to Longboard instructions and properly maintained, such product is further guaranteed against rusting and corroding. Subject to the limitations set out in Clause 3 and 4.
- 1.4 What we will do: If, during the twenty (20) year Limited Warranty Period on the powder coating finish, the Product is defective in material or workmanship, Longboard will, in its sole discretion, either repair or replace the defective portion of the Product.
- 1.5 What we will do: If, during the 50-year Limited Warranty Period on the aluminum extruded profiles, the Product is defective in material or workmanship, Longboard will, in its sole discretion, either repair or replace the defective portion of the Product.
- 1.6 After the 20th year, this Limited Warranty on the powder coated finish will expire and shall no longer be applicable.
- 1.7 After the 50th year, this Limited Warranty on the aluminum extruded profile(s) will expire and shall no longer be applicable.
- 1.8 Longboard replacement of the defective Product or reimbursement of this Limited Warranty is the exclusive remedy for the Covered Person for any defect in materials or workmanship. The Company will not refund or pay any costs in connection with labor or accessory materials.

Clause 2

- 2.1 During the first twenty (20) years of this warranty:
- 2.2 Checking/Cracking: No visible checking or cracking of the product finish on the building.
- 2.3 Chalking Resistance: No chalking of the product finish on the building in excess of that represented by No.8 rating based on ASTM D4214.
- 2.4 Color Retention: No color change of the product finish on the building greater than 5 (five) CIE Lab ΔE units calculated in accordance with ASTM 2244 Section 6.3. Color change shall be measured on the exposed paint surface which has been cleaned of oil, grease, chalk, oxidized film or other contaminants, corresponding values shall be measured on the control panel.
- 2.5 Gloss Retention: Coated surface will exhibit gloss retention

of a minimum of 30% of the original. Gloss retention shall be measured on the exposed paint surface which has been cleaned of oil, grease, chalk, oxidized film or other contaminants, corresponding values shall be measured on the control panel.

- 2.6 Adhesion: Adhesion of product finish when initially applied to test panels and measured by reference to AAMA 2604-02 Clause 7.4.2 will show no removal of the film.

Clause 3

- 3.1 Warranty Terms and Conditions:
- 3.2 The "Warranty Period" for the warranties in Clause 1 shall mean fifty (50) years or for as long as the original "owner" and/or "purchaser" named above shall live and own the property on which the material was originally installed.
- 3.3 Clause 3: Shall mean twenty (20) years, commencing on the date of completion.
- 3.4 Registration of the product is required for the warranty to be in effect. This warranty is valid for the original purchaser and one other owner of the structure where the product(s) have been installed.
- 3.7 Normal atmospheric conditions exclude corrosive or aggressive atmospheres such as those contaminated with chemical fumes or other corrosive elements. The Aluminate Ultra finish is not meant for marine use on boats, ships or offshore platforms.

Clause 4

- 4.1 This warranty will not extend or cover:
- 4.2 Damages to the coated metal caused by handling, shipping, processing and/or installation; or
- 4.3 Damages to the coated metal caused by scratching or abrading after installation; or
- 4.4 Damages to the coated metal as a result of standing water in horizontal installations.
- 4.5 The warranty will not be applicable to damage or failure, which is caused by acts of God, falling objects, external forces, explosions, fire, riots, civil commotion's, acts of war, or other such similar or dissimilar occurrences beyond The Company's control.
- 4.6 Customer shall make available to The Company the dates of the installation of the coated metal, the maintenance records including details of washing and cleaning procedures in compliance with the annual cleaning requirements as stated in the Required Maintenance section of this warranty. Customers shall demonstrate that the failure of the coated metal was due to a breach of the warranty stated herein.
- 4.7 Claims must be made in writing to Longboard within 30 days of the discovery of a problem and authorization obtained prior to beginning any repair and/or refinishing work. The claimant must provide proof of coverage. Claims can be made by writing to Longboard at the Product Performance Department. After receiving such notice, The Company

must be given a reasonable opportunity to inspect and verify the claim.

- 4.8 Longboard exclusive liability under this warranty, or otherwise, will be limited to refinishing and/or repairing, at The Company's sole discretion, the defective powder coating. The warranty on any refinished, repaired or replaced coated metal supplied hereunder shall be for the remainder of the warranty period applicable to the originally coated metal. All warranty work will be performed by a company or contractor selected by Longboard. Color variance between refinished and/or repainted product and original shall not be indicative of a defect.
- 4.9 This warranty represents the entire agreement between parties in relation to its subject matter and supersedes any previous agreement whether written or oral between the parties in relation to its subject matter. The limited warranties state the entire liability of Longboard with respect to the products covered by them. The Company shall have no liability for any incidental or consequential damages. No person is authorized to make any representation or warranty on behalf of Longboard except as expressly set forth above, and any such statement shall not be binding on The Company. Except as expressly set forth above, Longboard makes no warranty of any kind, express or implied, including, without limitation, any implied warranty of merchantability or fitness for a particular purpose. Warranties shall be the duration of the limited warranty, or such shorter duration as provided under applicable local law. These limited warranties give you specific legal rights, and you may also have other rights which vary from area to area.
- 4.91 Nothing in this warranty shall be construed as a warranty of the workmanship of any installer or as imposing on Longboard any liability for unsatisfactory performance caused by faulty workmanship in installation.
- 4.92 It's agreed all parties involved that all claims and disputes relating to this agreement that cannot be settled through negotiation will try in good faith to first settle the dispute by mediation administered by the American Arbitration Association (Construction Industry Mediation Procedures) as a prelude to mandatory binding arbitration. Such binding arbitration is to be conducted and administered by the Construction Industry Arbitration Rules of the American Arbitration Association. Both seller and purchaser agree to share equally in the costs of both mediation and arbitration and that such binding arbitration will be the sole and final remedial action.
- 4.93 Required Maintenance. On an annual basis use a soft sponge or cloth, water and mild detergent, non-abrasive soap with the pH range of 5-9 to clean the powder coated area of dirt, grime and other debris. Pressure washing and the use of harsh detergents or chemicals is not recommended. Include in your maintenance records the following: date, time, specific products used, name of maintenance person and their designation, maintenance company name and general condition of the powder coated finish.

I have read and agree to the terms of the Longboard® Product 20 year powder coated surface and 50 year aluminum extruded profile(s) warranty and acknowledge receipt of a copy of the Warranty Certificate.

Name of owner or contractor:

Date:

Signature:



Duly authorized on behalf of Longboard:

Name and designation:

Date:

Signature: